

G2+

golmar

UNIDAD DE RELÉ SAR-G2+

USER MANUAL



Cód. 50122550

TSAR-G2+ EN REV.0121

INTRODUCTION

First and foremost we would like to thank you for purchasing this product.

Our commitment to satisfying our customers can be seen from our ISO-9001 certification and from the manufacturing of products like this one.

Its advanced technology and exacting quality control will ensure that customers and users enjoy the many features this system offers. To obtain the maximum benefit from these features and a properly wired installation, we kindly recommend that you spend a few minutes of your time reading this manual.

CONTENTS

Introduction.....	2
Contents.....	2
Safety precautions.....	2
Characteristics.....	2
Operating modes.....	
Stairs light activation relay (necessary module SAR-12/24).....	3
Lock release activation relay (necessary power supply unit TF-104).....	3
Description of SAR-G2+ relay unit.....	
Description.....	4
Installation.....	
Detail of the installation of the SAR-G2+ relay unit.....	5
Operating mode description "Stairs light activation relay".....	5
Operating mode description "Lock release relay".....	6
Assigning of door panel and lock release control 1 or 2.....	6
Wiring diagrams.....	
Stairs light activation relay.....	7
Additional lock release activation relay.....	7

SAFETY PRECAUTIONS

- **Always disconnect the power supply** before making modifications to the device.
- The fitting and handling of these devices must be carried out by **authorised personnel**.
- The wiring must run at least **40cm away from any other wiring**.
- Do not overtighten the screws on the terminal block.
- Install the SAR-G2+ relay unit in a dry and protected location free from the risk of dripping or splashing water.
- Install the SAR-G2+ relay unit and SAR-12/24 together with the FA-G2+ power supply unit.
- Do not place in humid, dusty or smoky locations, or near sources of heat.
- The maximum consumption of relay contacts shall not exceed from 0,75A to 24 Vdc (18W) / 1A to 18 Vac (18VA).
- Before connecting the system to the mains, check the connections.
- Always follow the instructions contained in this manual.

CHARACTERISTICS

- Digital relay for the **G2+** system, allows the following operating modes:
 - ⇨ Stairs light activation relay (necessary module SAR-12/24).
 - ⇨ Golmar additional alternating lock release relay (necessary power supply unit TF-104).
- Necessary to configure operating mode of the SAR-G2+ relay unit.
- Connects to the Bus door panel.
- Configuration DIP switch.
- Operating status LEDs.
- The maximum consumption of relay contacts will be from 0,75A to 24 Vdc (18W) / 1A to 18 Vac (18VA).
- 12Vdc output to activate SAR-12/24 module in operating mode "stairs light activation".
- The SAR-G2+ relay unit counts as one element (monitor/telephone) in the installation.

OPERATING MODES

Stairs light activation relay (necessary module SAR-12/24):

- This operating mode allows activation of the stairs light from the apartment. (**Light operating mode: Set the Dip 4 to ON and from the Dip1 to Dip3 to OFF in the configuration SW1 dip switch of the SAR-G2+.**)

It will be activated by pressing the button located below the light icon  displayed on the screen in the settings menu of the ART 4 / ART 4 LITE monitor, in the main menu of the ART 7 / ART 7 LITE monitor, by clicking on the icon of the ART 7W monitor displayed on the screen in the main menu or pressing the button **AUX** for 3 seconds of the ART 1 terminal or T-ART telephone (in standby and handset on the hook on T-ART telephone).

- See user manual for monitor or terminal installed in the apartment.

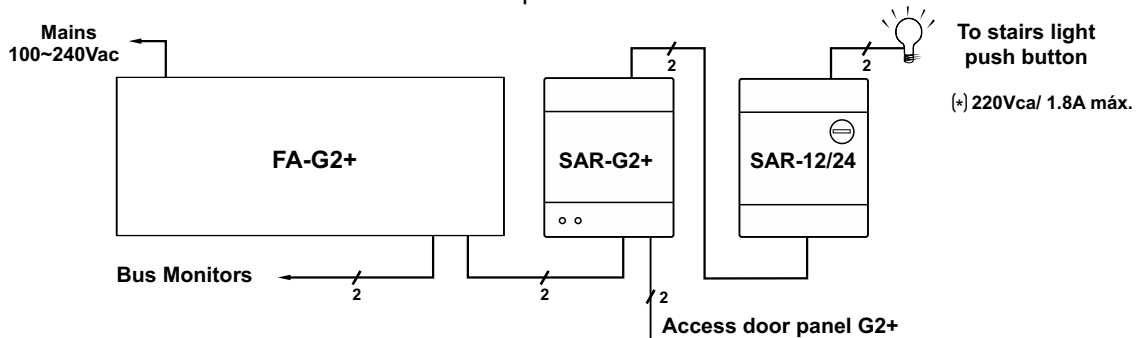

SAR-G2+ configuration SW1 dip switch:

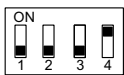

Light operating mode:
Dip 4 to ON.
Dip 1 to Dip3 a OFF.

JP1 jumper: Leave in the pos. 2-3.

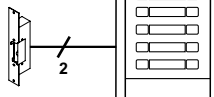



(*) Neutral point of the power supply of the stairs light is connected in series through the relay contacts of the SAR-12/24.

IMPORTANT: For the description, installation, configuration and programming of the system, see the corresponding manual.

Additional lock release activation relay (necessary power supply unit TF-104):

- This operating mode allows activation of a Golmar additional alternating lock release. This lock release is activated as lock release 1 or lock release 2 and with the panel that has been assigned (through configuration in SAR-G2+, see page 4) during a call or communication process.

It will be activated by pressing the button located below of corresponding icon  or  (lock release 1 or lock release 2 respectively) shown on the ART4/ ART4 LITE/ ART7/ ART7 LITE monitor screen, by clicking on the corresponding icon of the ART 7W monitor displayed on the screen or pressing the button **G** or **AUX** of the ART 1 terminal or T-ART telephone.

- See user manual for monitor/ audio terminal installed in the apartment.

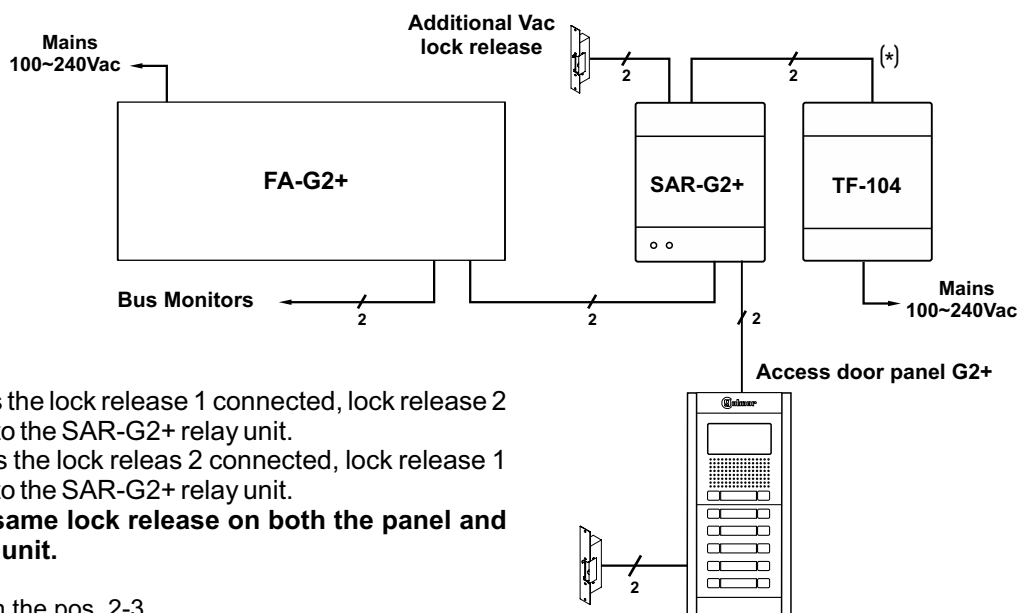

Important:

-If the door panel has the lock release 1 connected, lock release 2 must be connected to the SAR-G2+ relay unit.

-If the door panel has the lock releas 2 connected, lock release 1 must be connected to the SAR-G2+ relay unit.

Do not repeat the same lock release on both the panel and the SAR-G2+ relay unit.

JP1 jumper: Leave in the pos. 2-3.

(*) The power supply of the lock release is connected in series through the SAR-G2+ relay contacts.

IMPORTANT: For the description, installation, configuration and programming of the system, see the corresponding manual.

DESCRIPTION OF SAR-G2+ RELAY UNIT

Description:

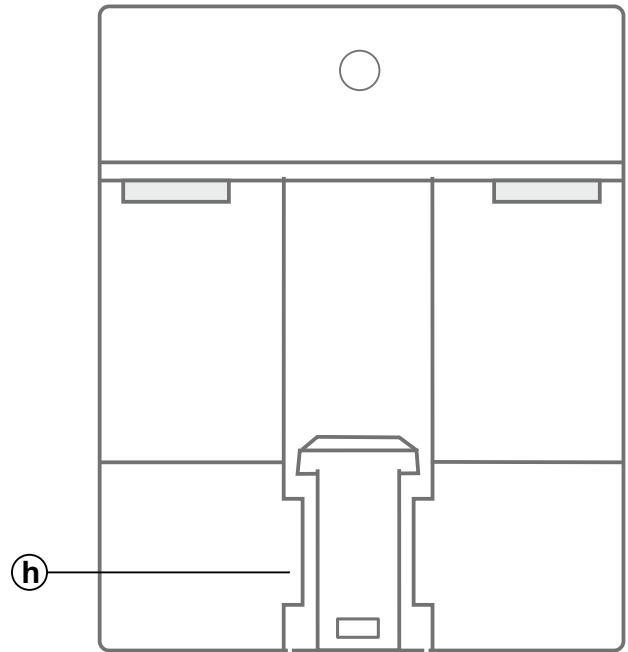
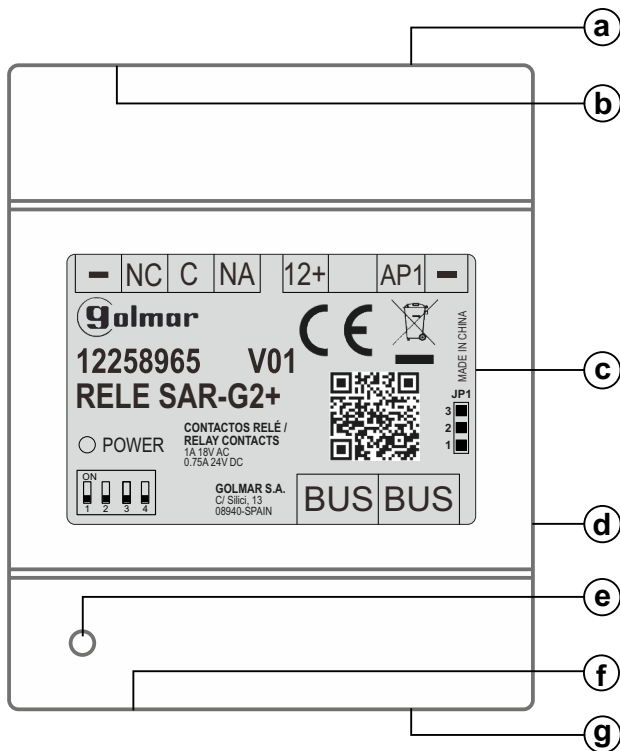

- a. 12Vdc and “AP1” output connector.
- b. Relay contact connector.
- c. Label.
- d. JP1 jumper (do not use). *Leave in the pos. 2-3.*
- e. Status LED (power supply).
- f. SW1 dip switch.
- g. Connection connector (G2+ BUS).
- h. DIN rail latch release.

Description of the configuration SW1 dip switch:



Relay unit assigned to access door **panel 1** (operating mode “**Lock release relay**”):
Dip 1 & Dip 2 to OFF (access door panel with address 1).



Relay unit assigned to access door **panel 2** (operating mode “**Lock release relay**”):
Dip1 to ON & Dip 2 to OFF (access door panel with address 2).

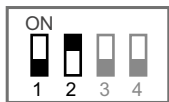

Relay unit assigned to access door **panel 3** (operating mode “**Lock release relay**”):
Dip 1 en OFF y Dip 2 en ON (access door panel with address 3).

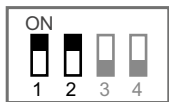

Relay unit assigned to access door **panel 4** (operating mode “**Lock release relay**”):
Dip 1 y Dip 2 en ON (access door panel with address 4).



Relay unit assigned to lock release 1 or 2 of the door panel (operating mode “**Lock release relay**”):
Dip 3 to OFF: **Lock release 1**.
Dip 3 to ON: **Lock release 2**.



Configures the Relay Unit to the operating mode:
Dip 4 to OFF: Operating mode “**Lock release relay**”.
Dip 4 a ON: Operating mode “**Stairs light activation relay**”.

INSTALLATION

Detail of the installation of the relay unit:

Install the relay unit in a dry and protected location free from the risk of dripping or splashing water. Install the SAR-G2+ relay unit and SAR-12/24 together with the FA-G2+ power supply unit.

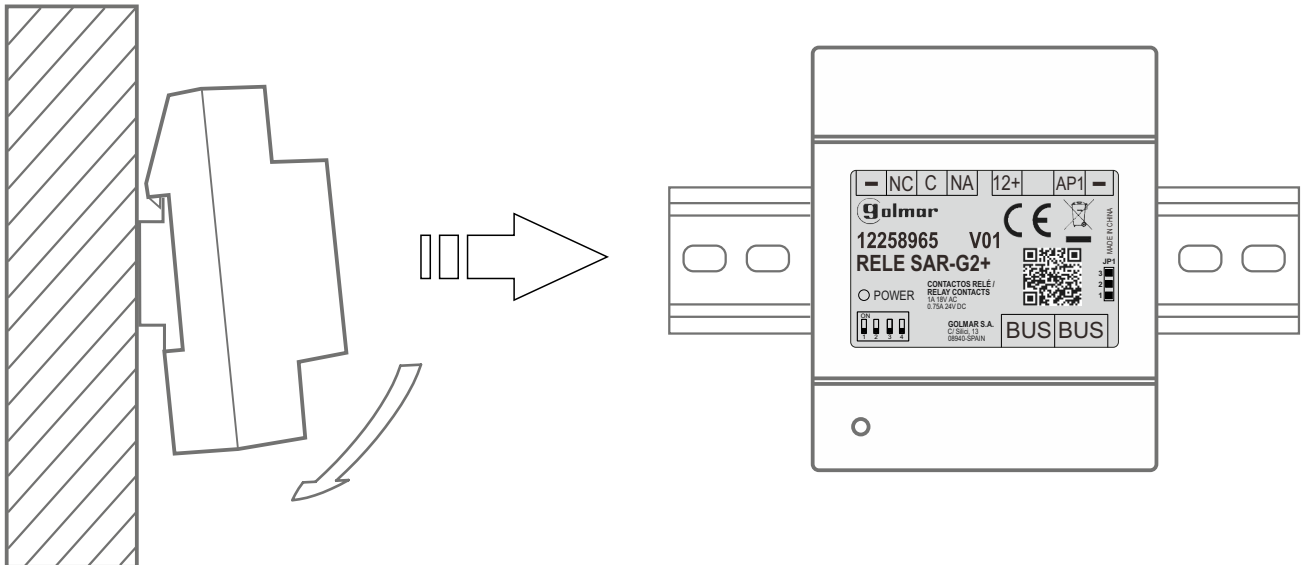

The relay unit can be mounted onto a DIN rail (4 elements) by applying slight pressure. To remove the relay unit from the rail, use a flat screwdriver and lever it off, as shown in the drawing.

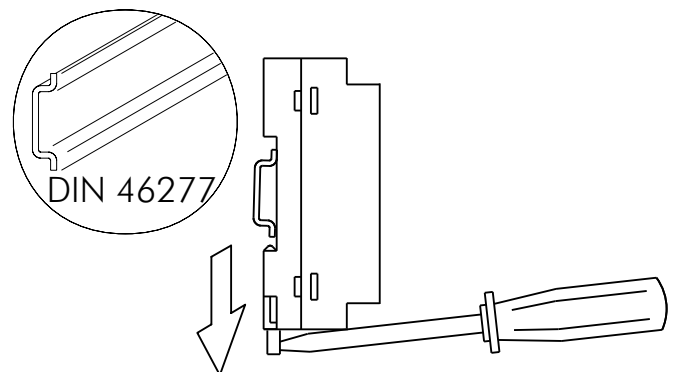

Description of the operating mode “Stairs light activation relay” (necessary module SAR-12/24):



- This operating mode allows activation of the stairs light from the apartment. **(Light operating mode: Set the Dip 4 to ON and from the Dip1 to Dip3 to OFF in the configuration DIP switch of the SAR-G2+).**
- It will be activated by pressing the button located below the light icon  displayed on the screen in the settings menu of the ART 4 / ART 4 LITE monitor, in the main menu of the ART 7 / ART 7 LITE monitor, by clicking on the icon of the ART 7W monitor displayed on the screen in the main menu or pressing the button **AUX** for 3 seconds of the ART 1 terminal or T-ART telephone (in standby and handset on the hook on T-ART telephone).
- See user manual for monitor or terminal installed in the apartment.
- **Note:** The activation time is 3 seconds (programmable by the installer).



Relay unit configured for operating mode “stairs light activation”.

INSTALLATION

Additional lock release activation relay (necessary power supply unit TF-104):

- This operating mode allows activation of a Golmar additional alternating lock release. This lock release is activated as lock release 1 or lock release 2 and with the panel that has been assigned (through configuration in SAR-G2+, see page 4) during a call or communication process.
It will be activated by pressing the button located below of corresponding icon  or  (lock release 1 or lock release 2 respectively) shown on the ART4/ ART4 LITE/ ART7/ ART7 LITE monitor screen, by clicking on the corresponding icon of the ART 7W monitor displayed on the screen or pressing the button  or **AUX** of the ART 1 terminal or T-ART telephone.
- See user manual for monitor/ audio terminal installed in the apartment.
- **Note:** The activation time is 3 seconds (programmable by the installer).
- The relay unit should be assigned to one of the 4 access panels that the system allows and define the push button of lock release 1 or 2 of the telephone / monitor that will activate the relay unit.
- **Note:** For the relay unit to activate in this operating mode, the assigned panel must be in a call or communication process.

Important:

- If the door panel has the lock release 1 connected, lock release 2 must be connected to the SAR-G2+ relay unit.
- If the door panel has the lock release 2 connected, lock release 1 must be connected to the SAR-G2+ relay unit.
- **Do not repeat the same lock release on both the panel and the SAR-G2+ relay unit.**

Assigning of door panel and lock release control 1 or 2.



Relay unit assigned to access door panel 1 and lock release 1.



Relay unit assigned to access door panel 1 and lock release 2.



Relay unit assigned to access door panel 2 and lock release 1.



Relay unit assigned to access door panel 2 and lock release 2.



Relay unit assigned to access door panel 3 and lock release 1.



Relay unit assigned to access door panel 3 and lock release 2.



Relay unit assigned to access door panel 4 and lock release 1.



Relay unit assigned to access door panel 4 and lock release 2.

WIRING DIAGRAMS

Stairs light activation relay:

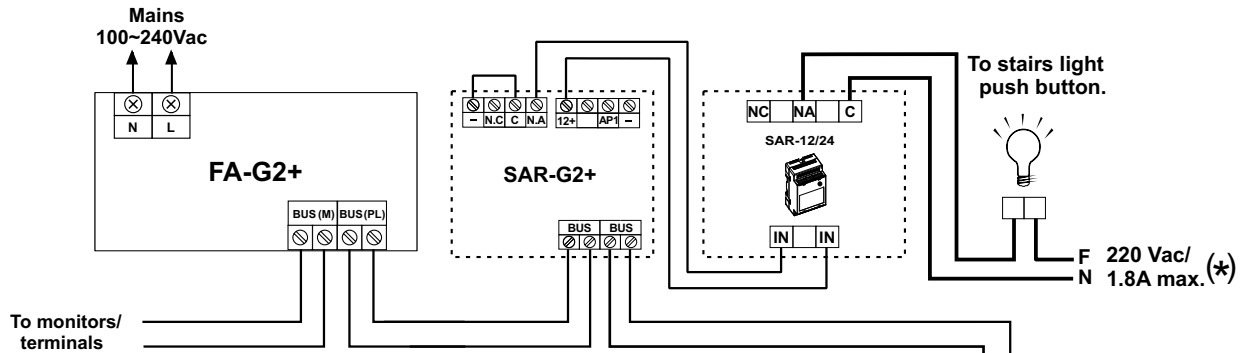

SAR-G2+ configuration SW1 dip switch:

Light operating mode: Dip 4 to ON.



Door panel 1: Dip 1 & 2 to OFF.
Dip 3: To OFF.

JP1 jumper: Leave in the pos. 2-3.

Important:

The minimum section of the cables connecting the output terminals of the relay SAR-12/24 is 1,5mm².

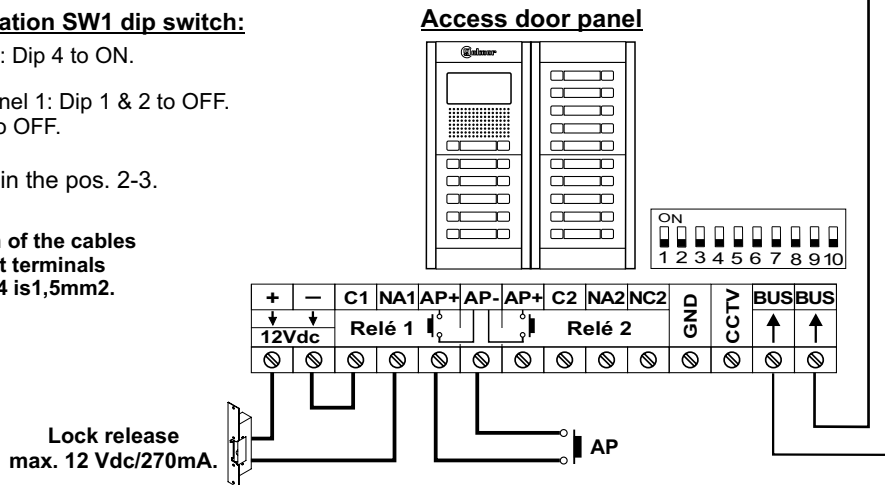

(*) Neutral point of the power supply of the stairs light is connected in series through the relay contacts of the SAR-12/24.

IMPORTANT: For the description, installation, configuration and programming of the system, see the corresponding manual.

Golmar additional alternating lock release relay:

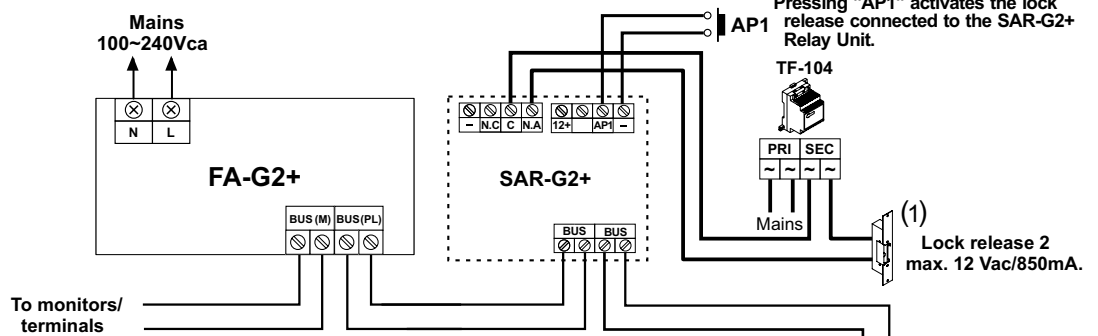

SAR-G2+ configuration SW1 dip switch:

Lock release operating mode: Dip 4 to OFF.

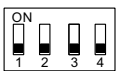

Lock release 1 (door panel 1) operating mode:

Door panel 1: Dip 1 & 2 to OFF.
Lock release 1: Dip 3 to OFF.

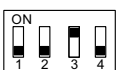

Lock release 2 (door panel 1) operating mode:

Door panel 1: Dip 1 & 2 to OFF.
Lock release 2: Dip 3 to ON.

Important: Must be configured in the SAR-G2+ the lock release (1 or 2) that is not being used on the door panel.

JP1 jumper: Leave in the pos. 2-3.

(1) Fit the varistor supplied with the sound module directly to the lock release terminals.

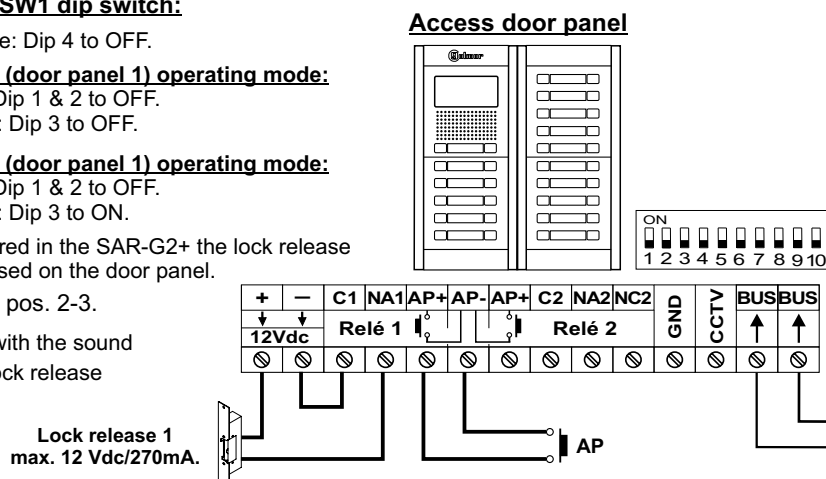

IMPORTANT: For the description, installation, configuration and programming of the system, see the corresponding manual.



golmar@golmar.es
www.golmar.es

GOLMAR S.A.
C/ Silici, 13
08940- Cornellá de Llobregat
SPAIN



Golmar se reserva el derecho a cualquier modificación sin previo aviso.
Golmar se réserve le droit de toute modification sans préavis.
Golmar reserves the right to make any modifications without prior notice.