

RELAY UNIT SAR-GB2

USER MANUAL



INTRODUCTION

First and foremost we would like to thank you for purchasing this product.

Our commitment to satisfying our customers can be seen from our ISO-9001 certification and from the manufacturing of products like this one.

Its advanced technology and exacting quality control will ensure that customers and users enjoy the many features this system offers. To obtain the maximum benefit from these features and a properly wired installation, we kindly recommend that you spend a few minutes of your time reading this manual.

CONTENTS

Introduction.....	2
Contents.....	2
Safety precautions.....	2
Characteristics.....	2
Operating modes.....	3
Description of SAR-GB2 relay unit.....	
Description.....	4
Installation.....	
Detail of the installation of the SAR-GB2 relay unit.....	4
Operating mode configuration.....	5
Operating mode description "Lock release relay".....	5
Assigning of door panel and lock release control 1 or 2.....	5
Relay unit lock release activation time.....	6
Operating mode description "Stairs light activation relay".....	7
Relay unit light activation time.....	7
Wiring diagrams.....	
Stairs light activation relay.....	8
Additional lock release activation relay.....	8
Notes.....	9

SAFETY PRECAUTIONS

- **Always disconnect the power supply** before making modifications to the device.
- The fitting and handling of these devices must be carried out by **authorised personnel**.
- The wiring must run at least **40cm away from any other wiring**.
- Do not overtighten the screws on the terminal block.
- Install the SAR-GB2 relay unit in a dry and protected location free from the risk of dripping or splashing water.
- Install the SAR-GB2 relay unit and SAR-12/24 together with the FA-GB2A power supply unit.
- Do not place in humid, dusty or smoky locations, or near sources of heat.
- The maximum consumption of relay contacts shall not exceed from 2A to 30 Vdc/ 1.25A to 48 Vac.
- Before connecting the system to the mains, check the connections.
- Always follow the instructions contained in this manual.

CHARACTERISTICS

- Digital relay for the **GB2** system, allows the following operating modes:
 - ⇒ Stairs light activation relay (necessary module SAR-12/24).
 - ⇒ Golmar additional alternating lock release relay (necessary power supply unit TF-104).
- Necessary to configure operating mode of the SAR-GB2 relay unit.
- Connects to the Bus door panel.
- Configuration DIP switch.
- Operating status LEDs.
- The maximum consumption of relay contacts will be from 2A to 30 Vdc (40w) / 1.25A to 48 Vac (40w).
- 12Vdc output to activate SAR-12/24 module in operating mode "stairs light activation".

OPERATING MODES

Stairs light activation relay (necessary module SAR-12/24):

- This operating mode allows activation of the stairs light from the apartment.
It is activated through the push button **AUX** of the telephone T-562 GB2 or Nhea GB2 and from the monitor light function Vesta2, Vesta7, Pentha or Thera.
- See user manual for telephone or monitor installed in the apartment.

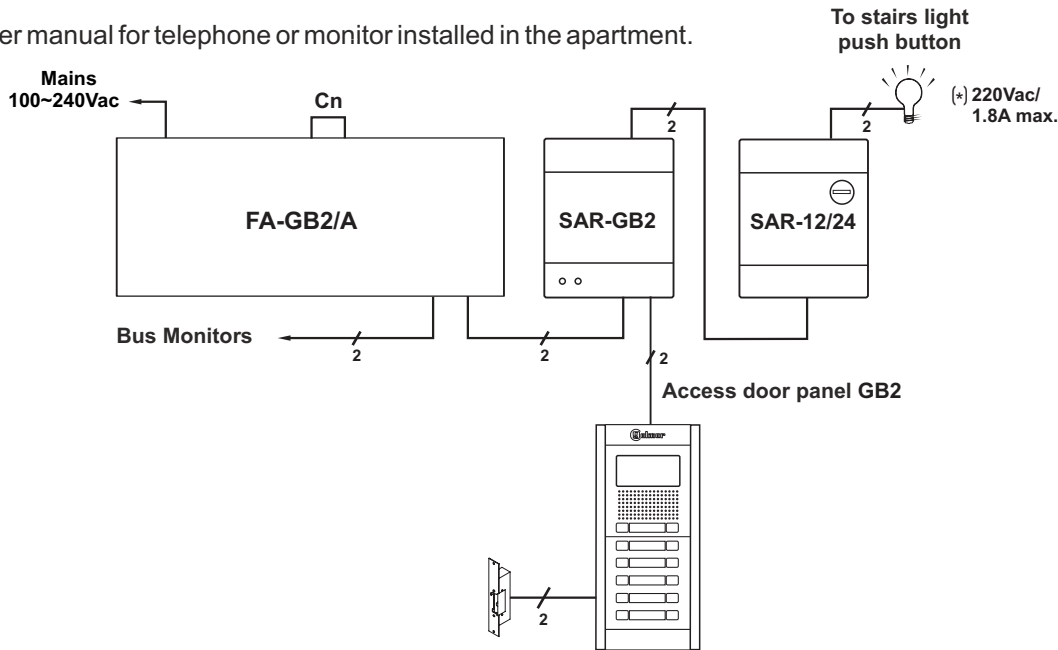

(*) Neutral point of the power supply of the stairs light is connected in series through the relay contacts of the SAR-12/24.
IMPORTANT: For the description, installation, configuration and programming of the system, see the corresponding manual.

Additional lock release activation relay (necessary power supply unit TF-104):

- This operating mode allows activation of a Golmar additional alternating lock release. This lock release is activated as lock release 1 or lock release 2 and with the panel that has been assigned (through configuration in SAR-GB2) during a call or communication process.
It will be activated through the push button or **AUX** (lock release 1 or lock release 2 respectively) of telephone T-562 GB2 or Nhea GB2 and through the push button for lock release 1 (or through the push button for lock release 2 of the Vesta7 monitor) or through the menu for lock release 2 of the Vesta2, Pentha or Thera monitor (for lock release 2 it is necessary to enable function 2nd lock release on Vesta2 monitor, see user manual for the monitor installed in the apartment).
- See user manual for telephone or monitor installed in the apartment.

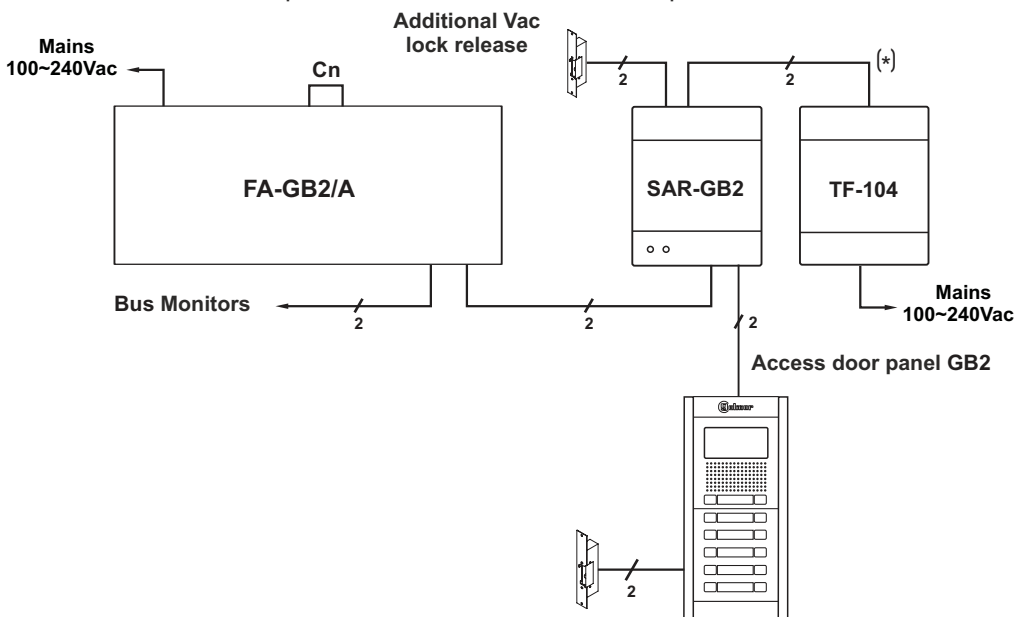

(*) The power supply of the lock release is connected in series through the SAR-GB2 relay contacts.
IMPORTANT: For the description, installation, configuration and programming of the system, see the corresponding manual.

DESCRIPTION OF SAR-GB2 RELAY UNIT

Description:

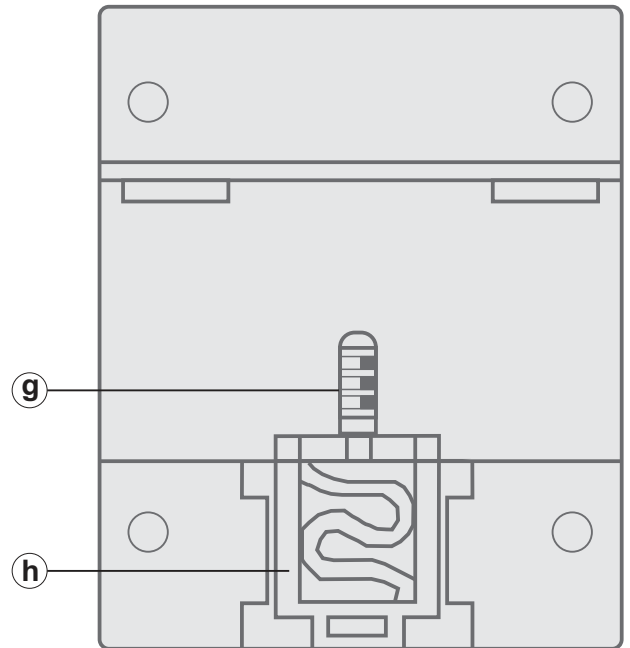
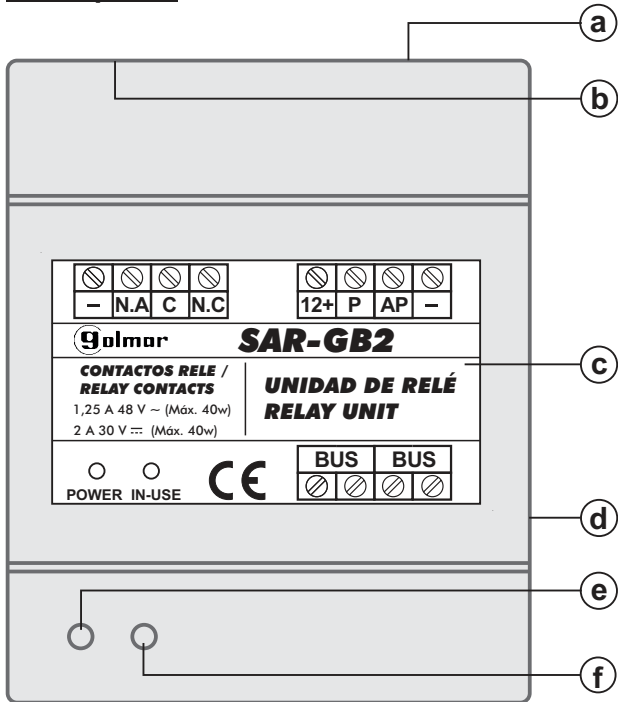

- a. 12Vdc and "AP" output connector.
- b. Relay contact connector.
- c. Label.
- d. JP jumper (do not use).

- e. Status LED (power supply).
- f. Status LED (active).
- g. SW1 dip switch.
- h. DIN rail latch release.

INSTALLATION

Detail of the installation of the relay unit:

Install the relay unit in a dry and protected location free from the risk of dripping or splashing water.
 Install the SAR-GB2 relay unit and SAR-12/24 together with the FA-GB2A power supply unit.

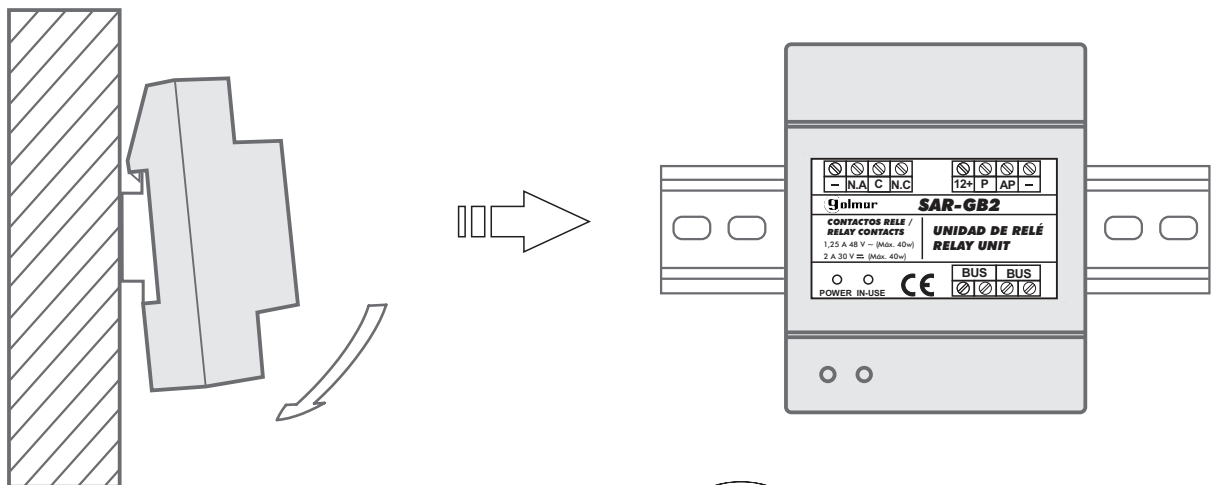

The relay unit can be mounted onto a DIN rail (4 elements) by applying slight pressure.
 To remove the relay unit from the rail, use a flat screwdriver and lever it off, as shown in the drawing.

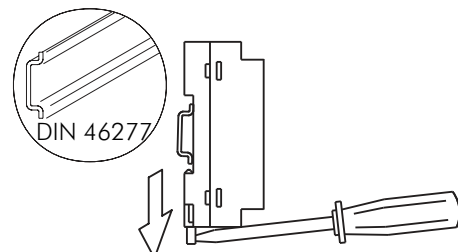

INSTALLATION

Operating mode configuration:

Relay unit allows 2 operating modes:

- Activation stairs light relay (necessary module SAR-12/24).
- Golmar additional alternating lock release relay (necessary power supply unit TF-104).

The relay unit is factory-setting in “lock release relay” operating mode.

Operating mode configuration:

Step 1: Remove the power supply from the SAR-GB2 relay unit by removing the relay unit Bus connector (The power supply status LED will turn off).

Step 2: Set DIP1 to ON, DIP2 to ON and DIP3 to OFF. On the dip switch Sw1 situated at the rear of the relay unit.

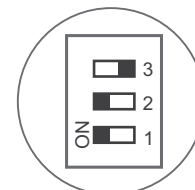

Step 3: On the power supply connector, join with a cable the terminals '-' and 'AP'.

Step 4: Connect the power supply to the SAR-GB2 relay unit by inserting the relay unit Bus connector. (LED showing the power supply status will turn on).

Step 5: In the first 5 seconds after connecting the power supply to the relay unit, move DIP1 from ON to OFF 4 times consecutively. After this the “in use” status LED will indicate:

- Status LED “in use”: 1 flash indicates that the operating mode is in Light activation relay.
- Status LED “in use”: 2 flashes indicates that the operating mode is in Lock release relay.

Step 6: Remove the power supply from the SAR-GB2 relay unit (see step 1).

Step 7: Set DIP1, DIP2 and DIP3, as defined in the configuration:·

- Operating mode lock release relay: See assigning of door panel and lock release control 1 or 2.
- Operating mode light activation relay: DIP1, DIP2 and DIP3 should be set to OFF.

Step 8: Remove the cable which joins the terminals '-' and 'AP'.



Step 9: Connect the power supply (see step 4).

Step 10: Check that the operating mode is correct, activating the light or lock release depending on the configuration.

Note: Repeat the procedure (steps 1 to 10) until the relay unit has been configured to the desired operating mode.

Operating mode “Lock release relay”:

- This operating mode allows activation of a Golmar additional alternating lock release. This lock release is activated as lock release 1 or lock release 2 and with the panel that has been assigned (see assigning relay unit to panel and lock release) during a call or communication process.

It will be activated through the push button  or AUX (lock release 1 or lock release 2 respectively) of telephone T-562 GB2 or Nhea GB2 and through the push button  for lock release 1 (or through the push button  for lock release 2 of the Vesta7 monitor) or through the menu for lock release 2 of the Vesta2, Pentha or Thera monitor (for lock release 2 it is necessary to enable function 2nd lock release on Vesta2 monitor, see user manual for the monitor installed in the apartment).

- See user manual for telephone or monitor installed in the apartment.

The relay unit should be assigned to one of the 4 access panels that the system allows and define the push button of lock release 1 or 2 of the telephone / monitor that will activate the relay unit.

Note: For the relay unit to activate in this operating mode, the assigned panel must be in a call or communication process.

Assigning of door panel and lock release control 1 or 2.



Relay unit assigned to access door panel 1 and lock release 1.



Relay unit assigned to access door panel 1 and lock release 2.

INSTALLATION

Continued from the previous page.



Relay unit assigned to access door panel 2 and lock release 1.

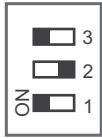

Relay unit assigned to access door panel 2 and lock release 2.



Relay unit assigned to access door panel 3 and lock release 1.



Relay unit assigned to access door panel 3 and lock release 2.

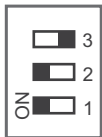

Relay unit assigned to access door panel 4 and lock release 1.

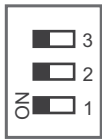

Relay unit assigned to access door panel 4 and lock release 2.

Relay unit lock release activation time.

Configuration:

- Step 1: Remove the power supply from the SAR-GB2 relay unit by removing the relay unit Bus connector (The power supply status LED will turn off).
- Step 2: Connect the power supply to the SAR-GB2 relay unit by inserting the relay unit Bus connector. (LED showing the power supply status will turn on).
- Step 3: In the first 5 seconds after connecting the power supply to the relay unit, bypass the terminals '-' and 'P' with a cable for 3 seconds (the status LED "in use" will flash).
- Step 4: Next, bypass the terminals '-' and 'AP' with a cable for 3 seconds (the status LED "in use" will light up continuously).
- Step 5: Bypass the terminals '-' and 'P' again. The time that the terminals '-' and 'P' are bypassed will configure the activation time of the relay unit (every flash of the status LED "in use" is equivalent to one second of the activation time). The maximum configurable time is 30 seconds.
- Step 6: After removing the bypass from the terminals '-' and 'P', the time that has been configured will be saved and the relay unit will come out of time configuration mode.
- Step 7: Check that the activation time of the relay unit is correct.

INSTALLATION

Operating mode “Stairs light activation relay”:

- This operating mode allows activation of the stairs light from the apartment. It is activated through the push button **AUX** of the telephone T-562 GB2 or Nhea GB2 and from the monitor light function Vesta2, Vesta7, Pentha or Thera.
- See user manual for telephone or monitor installed in the apartment.
- The dip switch SW1 of the relay unit must be configured with DIP1, DIP2 and DIP3 set to OFF.
- Maximum of one relay unit per system.
- Note: Once the relay unit has been activated, by default it will deactivate automatically after 1 minute.

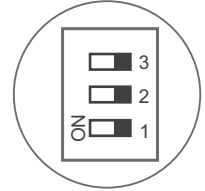

Relay unit light activation time:

Configuration:

- Step 1: Remove the power supply from the SAR-GB2 relay unit by removing the relay unit Bus connector (The power supply status LED will turn off).
- Step 2: Connect the power supply to the SAR-GB2 relay unit by inserting the relay unit Bus connector. (LED showing the power supply status will turn on).
- Step 3: In the first 5 seconds after connecting the power supply to the relay unit, bypass the terminals '-' and 'P' with a cable for 3 seconds (the status LED “in use” will flash).
- Step 4: Next, bypass the terminals '-' and 'AP' with a cable for 3 seconds (the status LED “in use” will light up continuously).
- Step 5: Bypass the terminals '-' and 'P' again. The time that the terminals '-' and 'P' are bypassed will configure the activation time of the relay unit (every flash of the status LED “in use” is equivalent to 30 seconds of the activation time). The maximum configurable time is 900 seconds.
- Step 6: After removing the bypass from the terminals '-' and 'P', the time that has been configured will be saved and the relay unit will come out of time configuration mode.
- Step 7: Check that the activation time of the relay unit is correct.

Note: The relay unit by default has a configured activation time of 1 minute.

WIRING DIAGRAMS

Stairs light activation relay:

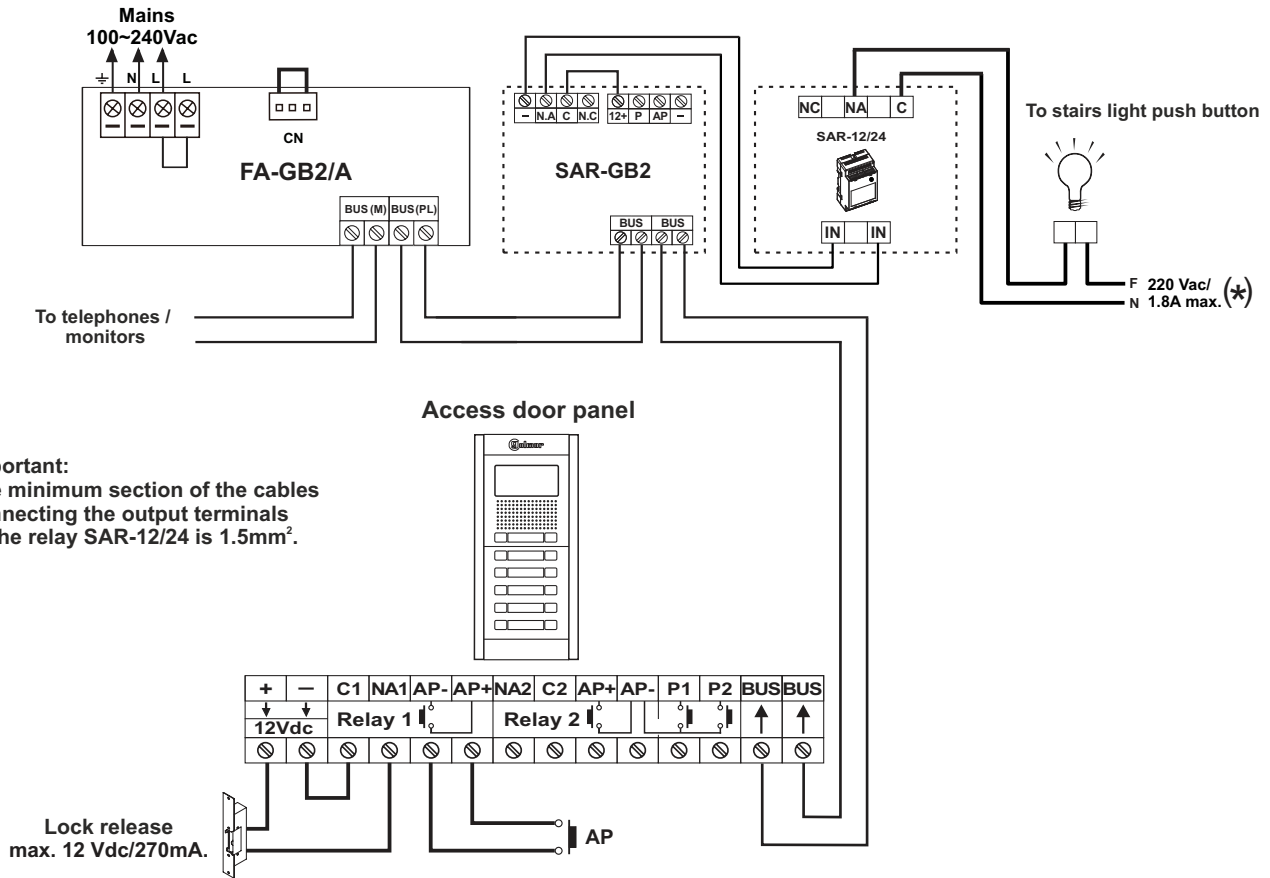

(*) Neutral point of the power supply of the stairs light is connected in series through the relay contacts of the SAR-12/24.

IMPORTANT: For the description, installation, configuration and programming of the system, see the corresponding manual.

Golmar additional alternating lock release relay:

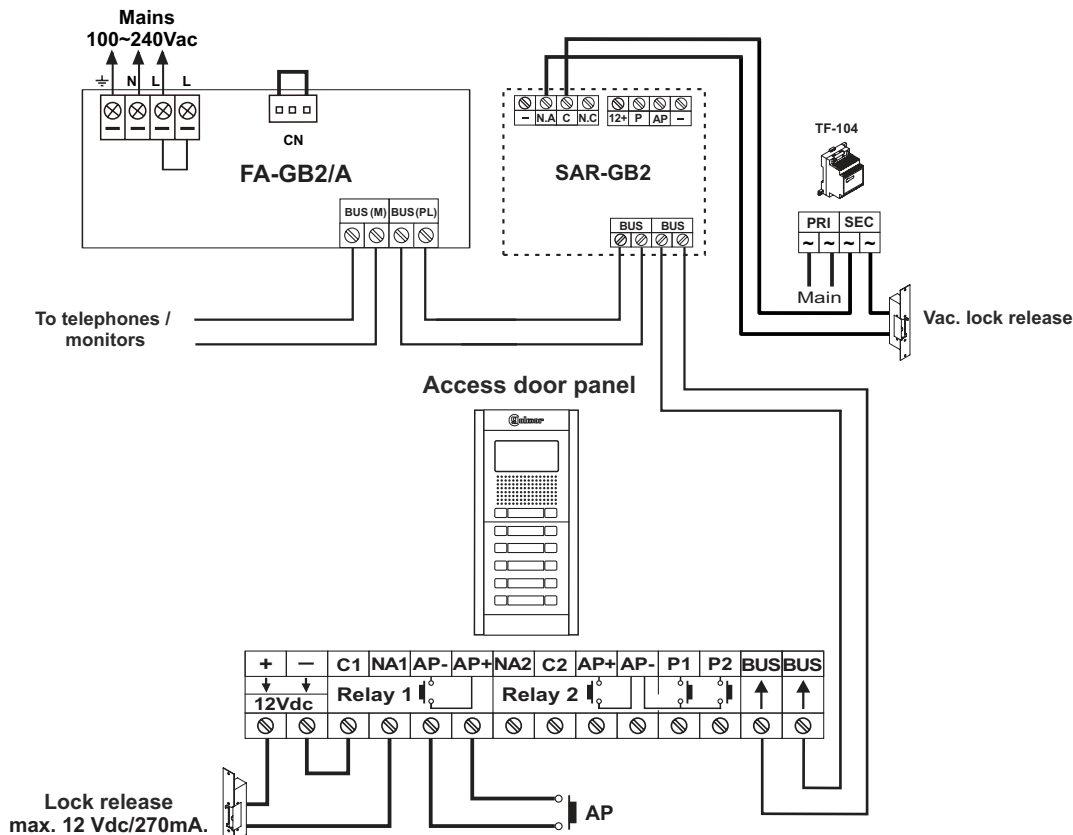

IMPORTANT: For the description, installation, configuration and programming of the system, see the corresponding manual.



golmar@golmar.es
www.golmar.es

GOLMAR S.A.
C/ Silici, 13
08940- Cornellá de Llobregat
SPAIN



Golmar se reserva el derecho a cualquier modificación sin previo aviso.
Golmar se réserve le droit de toute modification sans préavis.
Golmar reserves the right to make any modifications without prior notice.