

D2L-90/2H D4L-90/2H

Distribuidores de par trenzado de 2 y 4 salidas
Two and four twisted pair outputs splitters

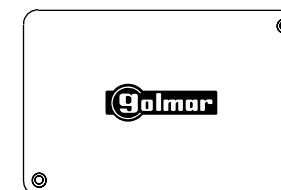

La comunicación por sistema.

Descripción / Description

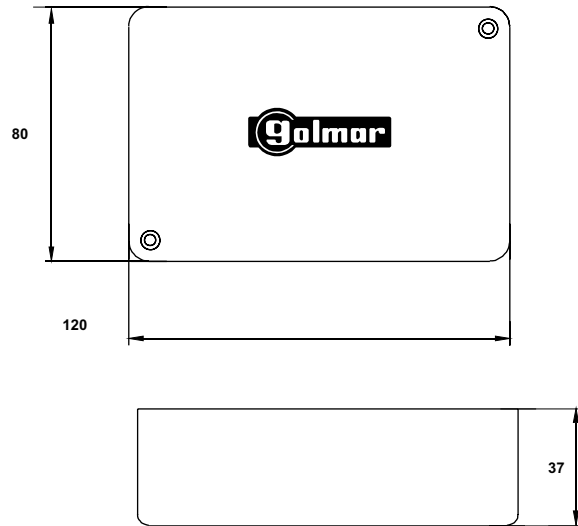

Instrucciones ubicadas en el fondo de la tapa / Instructions on the bottom splitter cover.

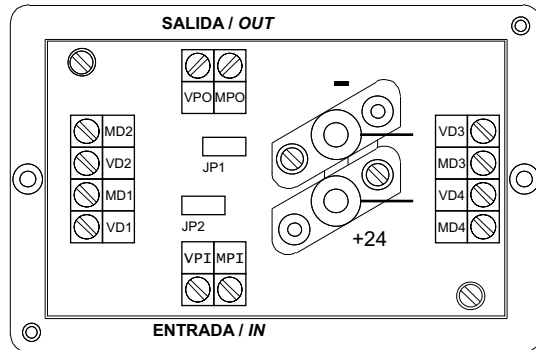

D2L-90/2H
D4L-90/2H

Distribución estándar D4L-90/2H / Standard distribution D4L-90/2H.

Secciones mínimas mm² / Minimum sections mm²

Señal Video	Video Signal	Bornes Terminals		100 m		200 m	
		MP	VP	0.22	0.22	0.5	0.75
Señal Audio	Audio Signal	⏏	⏏	1.0	2.0	1.0	2.0
Tensión Continua	Direct Current	+	-	1.0	2.0	1.0	2.0
Tensión Alterna	Altern Current	~1	~2	1.0	2.0	1.0	2.0

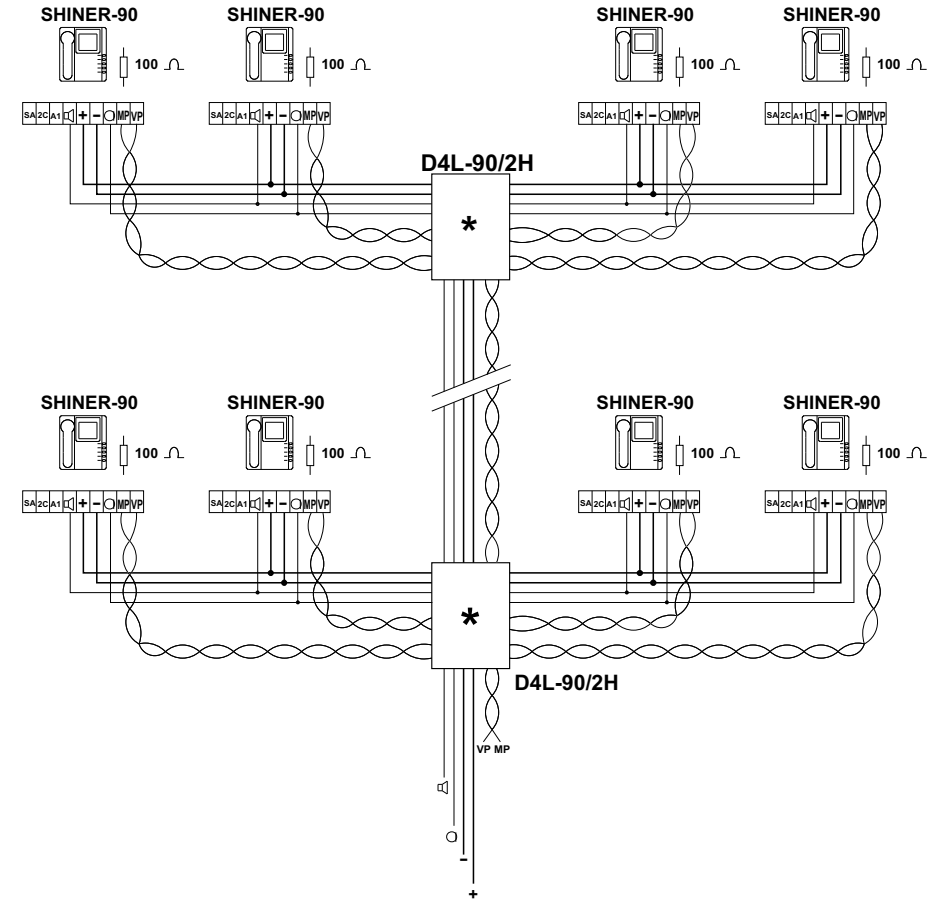

* Extraer los puentes JP1 y JP2 excepto en el último

* Remove bridges JP1 and JP2 except in the last

Distribución estándar D2L-90/2H / *Standard distribution D2L-90/2H.*

Secciones mínimas mm² / *Minimum sections mm²*

		Bornes Terminals		100 m	200 m
Señal Video	Video Signal	MP	VP	0.22	0.22
Señal Audio	Audio Signal	⏏	⊖	0.5	0.75
Tensión Continua	Direct Current	+	-	1.0	2.0
Tensión Alterna	Altern Current	~1	~2	1.0	2.0

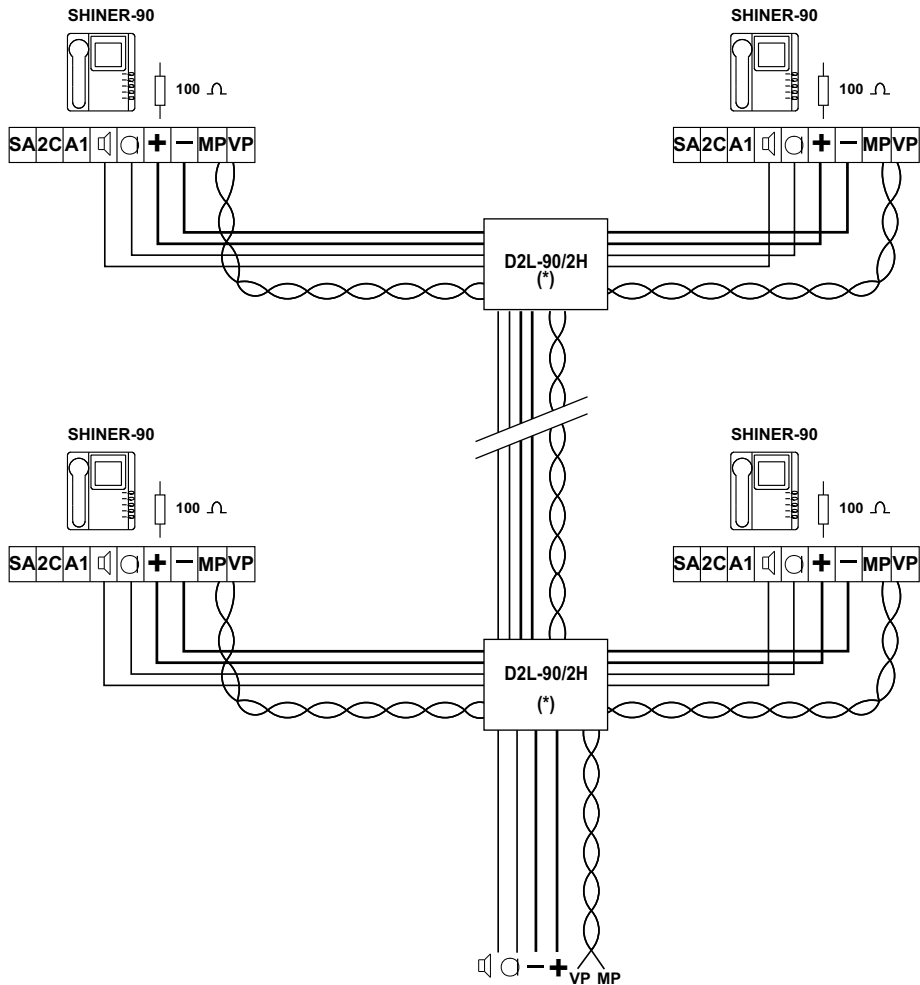

* SACAR LOS PUENTES JP1 Y JP2 EXCEPTO EN EL ULTIMO DISTRIBUIDOR

* REMOVE BRIDGES JP1 AND JP2 EXCEPT IN THE LAST SPLITTER

Instalación / Installation

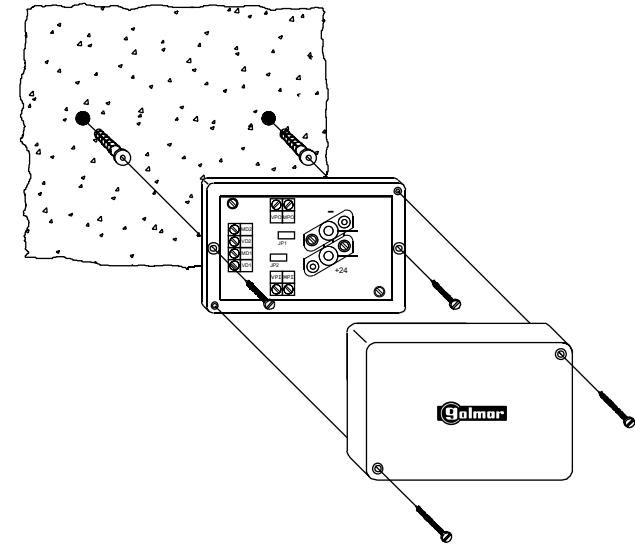

Fijar la base del distribuidor a la pared y colocar la tapa del distribuidor
Fix the base of the splitter to the wall and attach the cover.

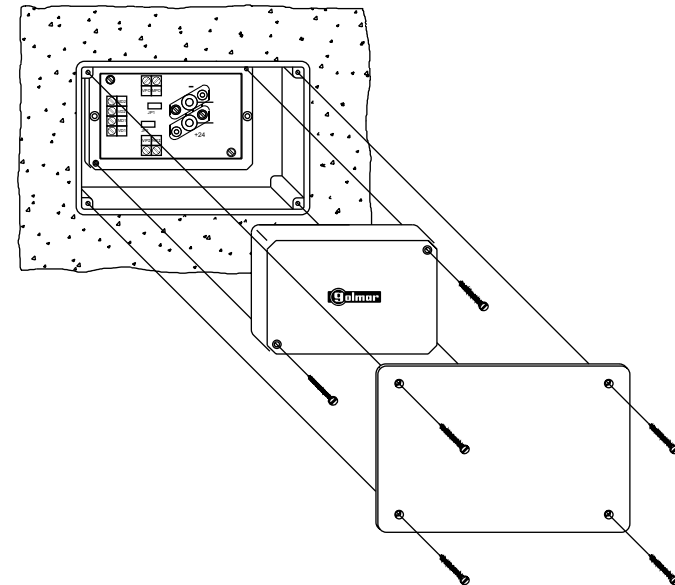

Ubicar la base del distribuidor en el fondo de la caja de empotrar
estandar, colocar las tapas del distribuidor y de la caja de empotrar .
*Place the base of the distributor in the standard flush-fitting box,
attach the cover of the distributor and the cover of the flush-fitting box.*

Conexión / Wire connection

Distribución en cascada / Serial distribution.

