

USER MANUAL



**NHEA PLUS SE TERMINAL
PLUS DIGITAL SYSTEM**



INTRODUCTION

First of all, we thank and congratulate you for purchasing this product manufactured by Golmar.

Our commitment to achieving the satisfaction of customers like you is manifested through our ISO-9001 certification and the manufacture of products like the one you have just purchased.

Its advanced technology and strict quality control will ensure that customers and users enjoy the numerous features that this device offers. To get the most out of them and ensure proper operation from day one, we recommend that you read this instruction manual.

CONTENTS

Introduction.....2

Contents.....2

Safety precautions.....2

Characteristics.....3

System operation.....3

Description of the terminal.....4

 Description.....4

 Status LED.....4

 Connection terminals.....4

 Connector terminals.....4

 Function buttons.....5

 Audio volume control.....5

 Call volume control.....5

 Installing the terminal in a wall mounting connector.....6

 Installing the terminal in an embedding box.....7

Programming the terminal.....8

Advanced programming (terminal functions).....8

 Menu 1.....9

 -Changing the ringtone melody.....9

 -Activating/deactivating the doctor mode function.....9

 Menu 2.....9

 -Intercom with Plus terminals, telephones and monitors.....9

 -Changing the button function .....10

 -Changing the button function **AUX**.....10

 Menu 3.....10

 -Repeating the ringtones.....10

 -Adjusting the 'door panel communication time'.....10

 -Adjusting the 'door panel call time'.....10

 Menu 4.....11

 -Setting all of the terminal's advanced programming options to the 'default value'.....11

Optional connections.....12

 -Activation of auxiliary devices.....12

 Exterior button input for activating the door panel look release.....12

 -Intercom within the same apartment.....13

 -Button for receiving calls from the apartment front door.....14

 -Cleaning the terminal.....14

Wiring diagram.....15













SAFETY PRECAUTIONS

- Do not overtighten the Nhea Plus SE terminal's fixing screws.
- **Always disconnect the power supply** before installing or making modifications to the device.
- The fitting and handling of these devices must be carried out by **authorised personnel**.
- All of the wiring must run at least **40cm away from any other wiring**.
- Install the Nhea Plus SE terminal in a dry protected location free from the risk of dripping or splashing water.
- Do not place in humid, dusty or smoky locations, or near sources of heat.
- Before connecting the device to the mains, check the connections between the door panel, power supply and terminals.
- Always follow the instructions contained in this manual.

CHARACTERISTICS

- Nhea Plus SE hands-free audio terminal for Plus installation.
- Terminal with 4 common wire installation.
- Function and advanced programming access buttons (to customise terminal functions).
- Totally private conversation.
- Auto switch-on function.
- 'Doctor mode' function (automatic door opening, see p. 9).
- Intercom between two devices in the same apartment.
- Apartment front door call input.
- Call reception volume control (maximum and minimum).
- Audio volume control (maximum and minimum).
- Call volume adjustment: maximum, minimum and no volume 'night mode' (see p. 5 'function buttons').
- Exterior button input for door panel lock release
- Output to auxiliary call repeater.
- Call to main and secondary guard unit.
- Panic call to guard units.
- Different ringtones to identify call origin: door panel, guard unit, intercom and interior door of apartment 'HZ.'
- Activation of auxiliary functions: courtesy lights, second lock release, etc.
- Configuration of the terminal as a slave and intercom (quick programming mode).
- Door release button.
- Terminal status LED.

SYSTEM OPERATION

- To make a call, the visitor presses the button for the apartment, a number of audible tones indicate that the call is being made and LED  on the door panel illuminates. At this moment, the apartment's terminal receives the call. If the visitor presses the button for another apartment by mistake, the call can be cancelled by pressing the button for the correct apartment.
- In systems with several access doors, the other door panel(s) automatically disconnects. If another visitor attempts to call, a number of telephone tones will indicate that the channel is busy and LED  on the door panel will illuminate.
- General entrance door panels (mode EL501): If the call is being made from the general entrance door panel, the interior door panel of the building being called and other possible general entrance door panels automatically disconnect. If another visitor attempts to call from either a busy interior door panel, a number of telephone tones will indicate that the channel is busy and LED  of the door panel will illuminate, or from another general entrance door panel, a number of telephone tones will indicate that the channel is busy and LED  of the general entrance door panel will blink for 3 seconds. The door panels of the other interior buildings will remain free to be used.
- General entrance door panels (mode EL501): If the call is made from an interior door panel, the other interior door panels will remain free to be used. It is only possible to make calls to interior buildings from the general entrance door panels when their door panels are not in use. If an attempt is made to make a call to a busy interior door panel, a number of telephone tones will indicate that the channel is busy and LED  of the general entrance door panel will blink for 3 seconds.
- The call lasts for 45 seconds and the status LED of the master terminal will illuminate (green). If the call is not answered within 45 seconds, the master terminal's status LED will illuminate (red), LED  on the door panel will turn off and the channel will be free.
- To establish communication, press button  of the terminal or lift the handset of the telephone (monitor), and the terminal's status LED (green) and the door panel's LED  will illuminate.
- Communication will last for one and a half minutes or until button  on the terminal is pressed again or the handset of the telephone (monitor) is replaced. After communication, the terminal's status LED will illuminate (red), the door panel's LED  will turn off and the channel will be free.
- To open the door, press door release button  during the call or communication processes: one press will activate the lock release for 3 seconds and LED  will also illuminate for 3 seconds.
- A description of the function buttons can be found on p. 5.

DESCRIPTION OF THE TERMINAL

Description of the NHEA PLUS SE terminal

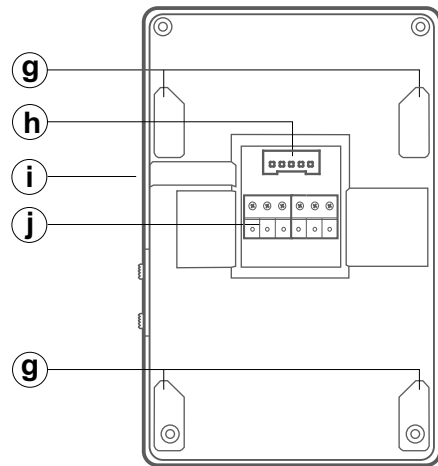
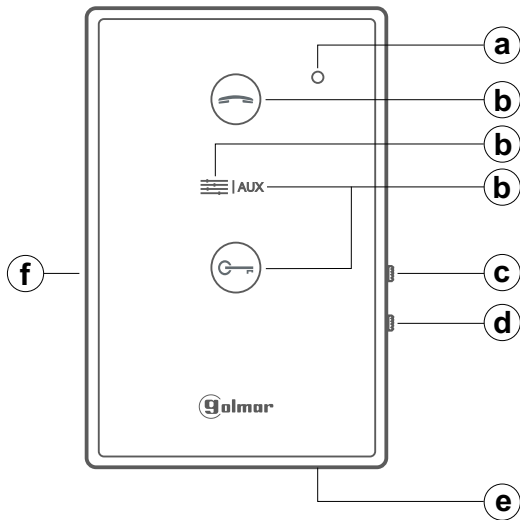

- a.** Status LED.
 - Standby: LED illuminated red.
 - Call: LED illuminated green. (master Nhea terminal).
 - Communication: LED illuminated green.
 - Night mode: LED blinking red.
 - Doctor mode: LED blinking green.
- b.** Function buttons.
- c.** Audio volume control switch.
- d.** Ringtone volume control switch.

- e.** Microphone.
- f.** Speaker.
- g.** Connector fixings.
- h.** Connector.
- i.** Horizontal cable entry.
- j.** Connection terminals

Description of the connection terminals:

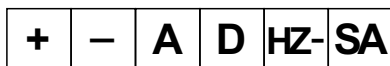

- +, - : Positive, negative (18Vdc power supply)
- A, D : Audio, digital communication.
- HZ- : Door bell button input.
- SA : Output (negative) auxiliary call repeater (max. consumption 250mA).

Description of the connector terminals:

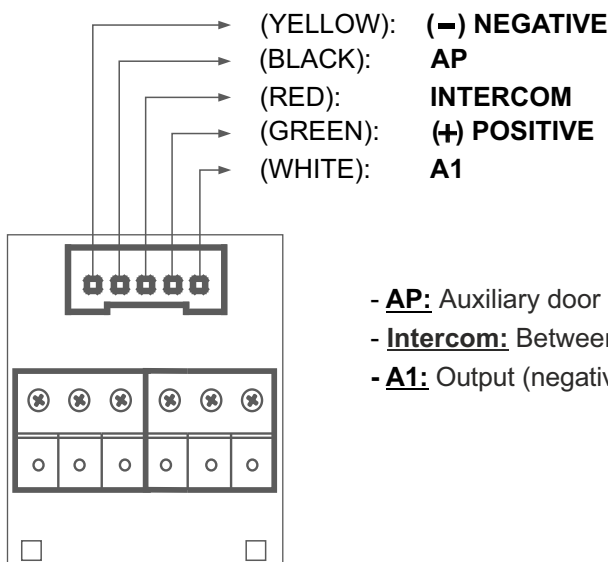

- **AP:** Auxiliary door opening button input.
- **Intercom:** Between two or more terminals in the same apartment.
- **A1:** Output (negative) auxiliary device activation (max. consumption 50mA).

DESCRIPTION OF THE TERMINAL

Function buttons:

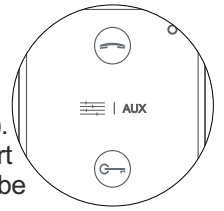

Start/stop communication button.

With the terminal in standby:

A short 1-second press activates the terminal in function mode (for 5 seconds).
A long 3-second press turns off the terminal. With the terminal turned off, one short 1-second press turns on the terminal (over the next 45 seconds, no operation can be performed in 'function mode').

In function mode:

A long 3-second press turns off the terminal. With the terminal turned off, one short 1-second press turns on the terminal (over the next 45 seconds, no operation can be performed in 'function mode').

During a communication process:

The talk/listen function is activated.



With the terminal in standby:

One long 3-second press activates 'ringtone volume mode', with a tone indicating the current volume selected. Then each long 3-second press (before 5 seconds elapse) selects a ringtone volume level and so on (in carousel mode) with the following selections (maximum, minimum and no volume 'night mode'. Note: The 'night mode' status LED blinks red). During a call process, the terminal will emit a ringtone and exit volume mode.

Regardless of the volume selected, the 'apartment interior door call' ringtone will always sound at maximum volume.

In function mode:

A short 1-second press activates the auto switch-on function, enabling audio communication with door panels that have this function activated to be established. This only functions if no communication is in progress.



Auxiliary device 'A1' is activated at any time (regardless of whether the terminal is in standby or function, call, communication or intercom mode).



With the terminal in standby:

A short 1-second press makes a panic call to the units configured to receive such calls.

In function mode:

A short 1-second press makes a normal call to the main unit.

During call reception and communication processes:

A short 1-second press activates the lock release for 3 seconds.

(*) In advanced programming mode (see p. 10), the default functions of function buttons and **AUX** can be changed with one of the following functions at the same time and per button:

-Function button :

Activation of auxiliary device 'A1,' call to secondary guard unit or **(1)** auto switch-on.

-Function button **AUX**:

(1) Activation of auxiliary device 'A1,' call to secondary guard unit, auto switch-on or intercom.

(1) Factory setting

Audio volume control:

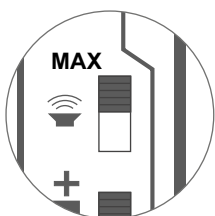

The terminal has a communication audio volume control with maximum and minimum volume settings.

Call volume control:

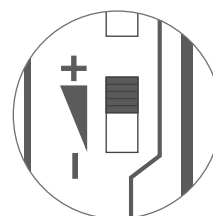

The terminal has a call volume control with maximum and minimum volume settings.

INSTALLING THE TERMINAL IN A WALL MOUNTING CONNECTOR

Avoid dusty or smoky environments or locations near sources of heat.

Positioning the wall mounting connector:

The top of the connector must be positioned at a height of 1.60m. The minimum distance between the sides of the connector and the closest object must be 5cm.

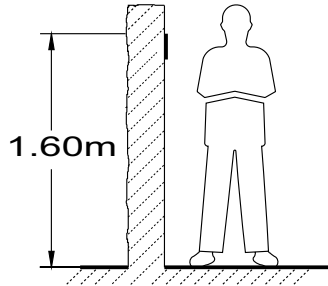

Fixing the terminal's wall mounting connector to the wall:

Fix the terminal's wall mounting connector to the wall by drilling two 6mm diameter holes and using the screws and plugs supplied with the terminal.

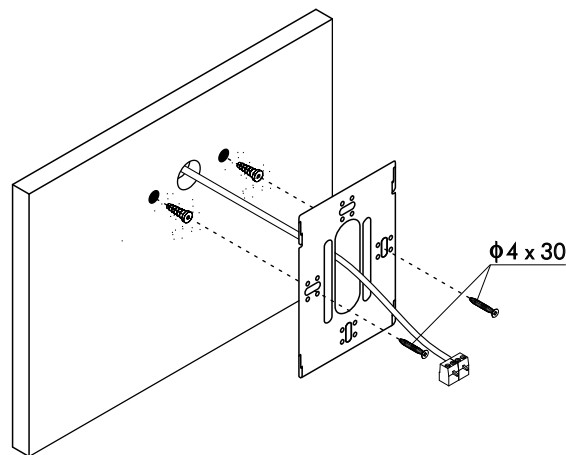

Positioning the terminal:

Connect the cables to the terminal (see p. 4), position the terminal in front of the wall mounting connector, ensuring that the holes in the base of the terminal line up with those on the connector ①, and then move the terminal downwards ② until the terminal is securely fixed to the connector ③.

Remember to remove the protective covering from the front of the terminal once installation has been completed.

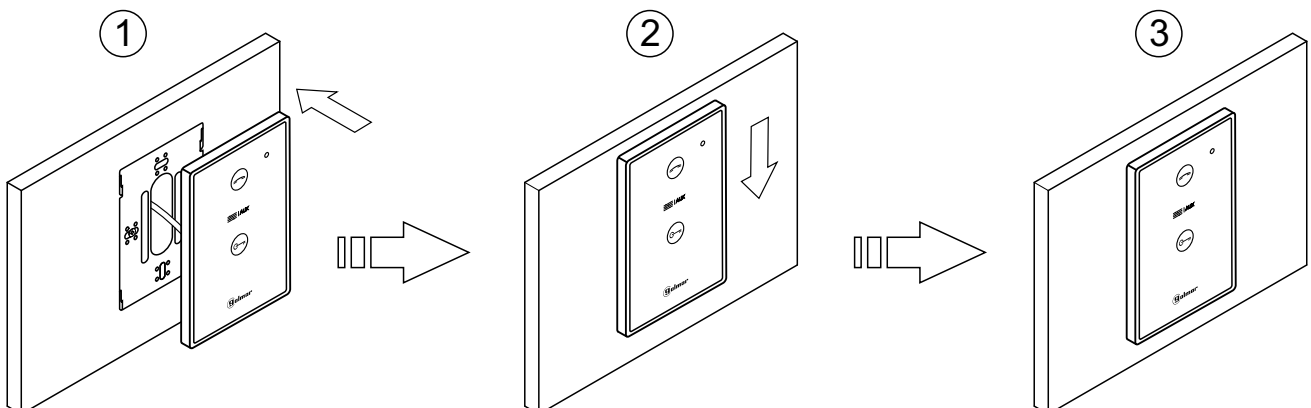

INSTALLATION OF THE TERMINAL IN AN EMBEDDING BOX

Avoid dusty or smoky environments or locations near sources of heat.

Location of the embedding box:

Make a hole in the wall to position the top of the universal embedding box at a height of 1.60 m from the ground. The minimum distance between the sides of the embedding box and the closest object must be 5cm.

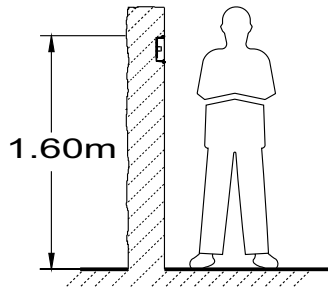

Positioning the embedding box and fitting the wall mounting connector:

Pass the cable through the hole made in the embedding box. Embed the box and ensure that it is level and flush. Fix the wall mounting connector of the terminal to the embedding box with the screws supplied.

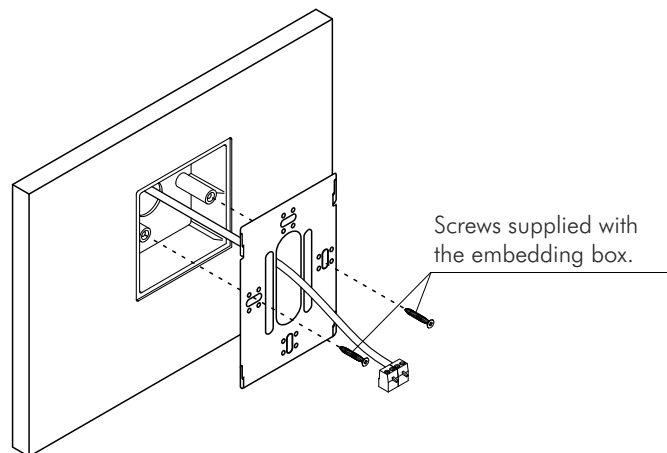

Positioning the terminal:

Connect the cables to the terminal (see p. 4), position the terminal in front of the wall mounting connector, ensuring that the holes in the base of the terminal line up with those on the connector ①, and then move the terminal downwards ② until the terminal is securely fixed to the connector ③.

Remember to remove the protective covering from the front of the terminal once installation has been completed.

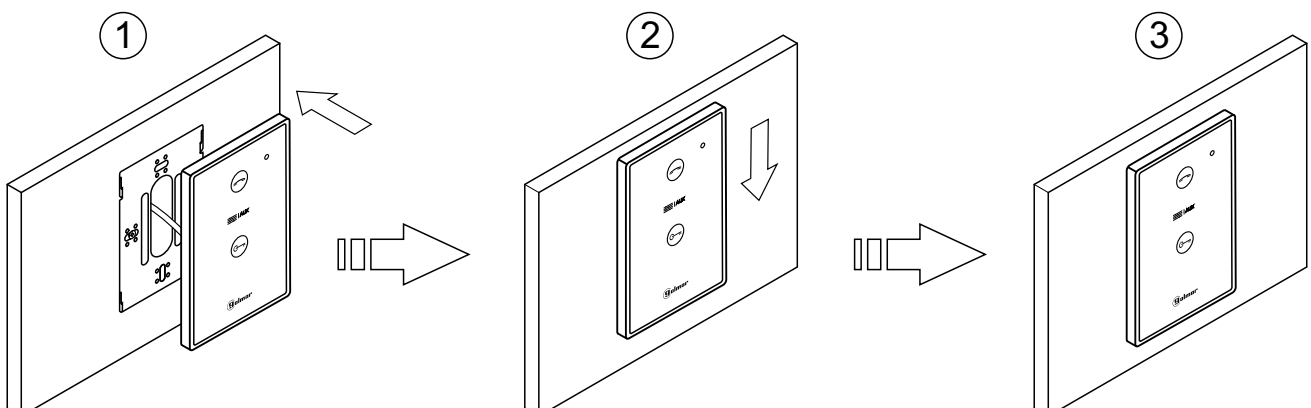

PROGRAMMING THE TERMINALS

Programming the NHEA Plus SE terminals:

Locate the SW2 DIP switch situated on the top left-hand side of the back of the EL632/PLUS module and set number 2 to ON. The door panel will reproduce a sound to advise that the system has entered into programming mode.

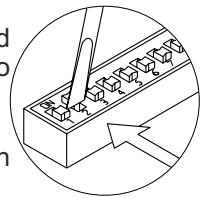

In systems with more than one door panel, only perform this procedure on the main door panel of each building.

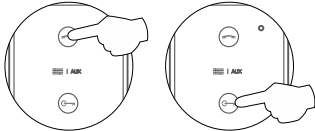

Turn off the terminal to be programmed (press button  for 3 seconds). Once switched off, press the door release button.

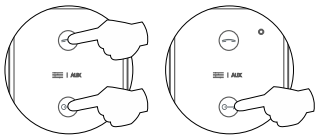

Press and hold the door release button and, without releasing it, switch on the terminal (press button  for 1 second).



To show that the device is ready for programming, the door panel and terminal will emit a number of tones (the status LED on the terminal will illuminate red), enabling the door release button to be released. The terminal is in audio communication with the door panel.



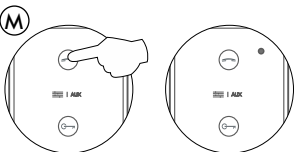

Press the button of the door panel that will call this terminal. At this moment, the door panel and terminal handset will emit a number of tones (the status LED on the terminal will blink red and LED  will illuminate).



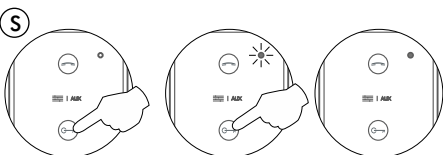

To programme the terminal as **Master**, press button  for 1 second (the terminal's LED will illuminate red and LED  will turn off).

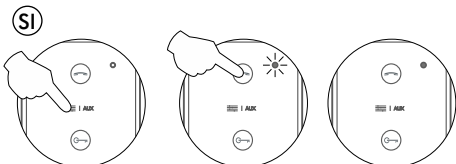

To programme it as **Slave 1**, press button  once, and the status LED will blink (green) once. Continue successively to **Slave 4**, pressing button  four times, and the status LED will blink (green) four times.



To programme the terminal as **Slave + Intercom**, press button  and the LED will blink (green) once. Then press button  for 1 second (the terminal's status LED will illuminate red and LED  will turn off).

Each apartment must only have one master unit; if there are parallel units, either terminals or monitors, they must be configured as slaves.

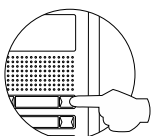

Make a call to check that the terminal has been successfully programmed. Programme the other terminals in the same way.



Once the programming has finished, set the programming switch to OFF. If this is not done, the door panel will emit tones to indicate that the system is still in programming mode.

PROGRAMMING THE TERMINALS

Advanced programming of the NHEA Plus SE terminals:

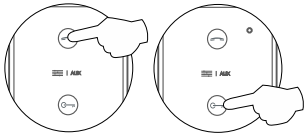
Advanced programming enables the terminal's default settings to be changed:



Turn off the terminal to be programmed (press button  for 3 seconds). Once switched off, press button  for 3 seconds to enter 'Menu 1' of advanced programming, the terminal will emit a number of tones and the LED will illuminate yellow.

Menu 1:

Then adjust the settings as required:

- Changing the ringtone melody:

The terminal has different ringtones to identify the origin of the call. The melodies assigned by default to the ringtones can be selected from among others available on the terminal.



Select the ringtone to be changed: Each press on button  selects a ringtone which is indicated with blinks (1 to 4 blinks) of the status LED and in the following order: door panel, guard unit, intercom call and 'HZ' apartment interior door call. When the final selection is reached, the following press returns the user to the first selection and the status LED blinks once (carousel mode).



Then select the melody for the ringtone (selected in the previous step) by pressing button  until the required 'carousel mode' melody is heard.

- Activating/deactivating the doctor mode function: Doctor mode not activated (default setting).

The 'doctor mode' function enables the lock release to be activated automatically 10 seconds after making a call from the door panel without having to establish communication or press door release button . The call ends after 20 seconds and the channel is free.

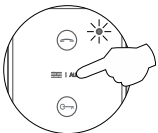

(Only the master terminal should be configured with 'doctor mode').



To activate doctor mode: Press button **AUX**, and the status LED will indicate with 2 blinks that the function is activated or with 1 blink that the function is deactivated.

- Accessing 'Menu 2' or exiting programming mode:



To access 'Menu 2,' press button , and the status LED will blink twice. To exit programming mode, press button  for 3 seconds, and the status LED will turn off (see p. 11).

Menu 2:

Then adjust the settings as required:

- Intercom with Plus telephones/monitors: Intercom with Plus SE terminals, telephones/monitors (default setting).

If an apartment has T-540 Plus telephones, Tekna Plus monitors and NHEA Plus SE terminals, the NHEA Plus SE terminals must be configured in 'Intercom with Plus telephones/monitors' mode, as T-540 Plus telephones and Tekna Plus monitors do not allow an intercom call to a particular telephone/monitor in the apartment to be made. That way, when an intercom call is made, all of the terminals, monitors/telephones in the apartment will receive the call.





To activate the 'Intercom with Plus telephones/monitors' mode: Press button , and the status LED will indicate with 1 blink that the function is in 'Intercom with Plus telephones/monitors' mode or with 2 blinks that the function is in 'Intercom with Plus SE terminals, telephones/monitors' mode.

PROGRAMMING THE TERMINALS

Continued from previous page

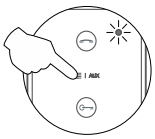
- Changing the function of button : Auto switch-on function (default setting).



Select the function to assign to button : Each press on button  selects a different function which is indicated with blinks (1 to 3 blinks) of the status LED and in the following order: activation of auxiliary device 'A1,' call to secondary guard unit, auto switch-on. When the final selection is reached, the following press returns the user to the first selection and the status LED blinks once (carousel mode).

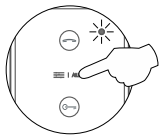

- Changing the function of button **AUX: Activation of auxiliary device 'A1' function (default setting).**



Select the function to assign to button **AUX**: Each press on button **AUX** selects a different function which is indicated with blinks (1 to 4 blinks) of the status LED and in the following order: activation of auxiliary device 'A1,' call to secondary guard unit, auto switch-on and intercom. When the final selection is reached, the following press returns the user to the first selection and the status LED blinks once (carousel mode).

- Accessing 'Menu 3' or exiting programming mode:



To access '**Menu 3**,' press button , and the status LED will blink 3 times. To exit programming mode, press button  for 3 seconds, and the status LED will turn off (see p. 11).

Menu 3:

Then adjust the settings as required:

- Repeating the ringtones: One repeat (default setting).



To 'repeat the ringtone' on the terminal: Each press on button  selects a repeat of the ringtones which is indicated with blinks (1 to 3 blinks) of the status LED and in the following order: 1, 2 or 3 repeats. When the final selection is reached, the following press returns the user to the first selection and the status LED blinks once (carousel mode).

- Adjusting the 'door panel communication time': 90 seconds (default setting).

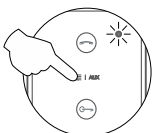

To adjust the 'door panel communication time': Each press on button  selects a door panel communication time (1:60 seconds, 2: 90 seconds, 3: 120 seconds, and 4: 150 seconds), which will be indicated with blinks (from 1 to 4 blinks) on the status LED and in the following order: 1, 2, 3 or 4 repetitions. When the final selection is reached, the following press returns the user to the first selection and and the status LED blinks once (carousel mode).

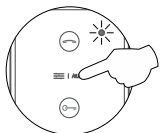

- Adjusting the 'door panel call' time: 45 seconds (default setting).



To adjust the 'door panel call' time: Each press on button **AUX** selects a door panel call time (1: 30 seconds, 2: 45 seconds, 3: 60 seconds, and 4: 90 seconds), which will be indicated with blinks (from 1 to 4 blinks) on the status LED and in the following order: 1, 2, 3 or 4 repetitions. When the final selection is reached, the following press returns the user to the first selection and and the status LED blinks once (carousel mode).

- Accessing 'Menu 4' or exiting programming mode:



To access '**Menu 4**,' press button , and the status LED will blink 4 times. To exit programming mode, press button  for 3 seconds, and the status LED will turn off (see p. 11).

PROGRAMMING THE TERMINALS

Continued from previous page

Menu 4:

Then adjust the settings as required:

- Setting all of the terminal's advanced programming options to the '**default value**'.



Setting to the 'default value': Press button , and the terminal will indicate with two audible tones that all of the options of the terminal's advanced programming (p. 9-10) are set to their default value.

- Button  has no function.

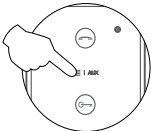

Reserved.

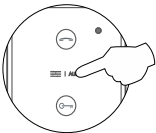

- Button **AUX** has no function.



No function.

- **Accessing 'Menu 1' or exiting programming mode:**



To access '**Menu 1**', press button , and the status LED will blink once (see p. 9).
To exit programming mode, press button  for 3 seconds, and the status LED will turn off.

- **Turning on the terminal when exiting programming:**

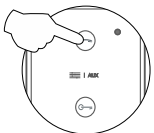

When exiting advanced programming mode, the terminal will be turned off: Press button  for 1 second to turn the terminal back on. After any resetting of the terminal and for the following 45 seconds, no operation with it can be performed.

OPTIONAL CONNECTIONS

Activation of auxiliary devices with NHEA Plus SE terminals:

Auxiliary device activation requires the use of an SAR-12/24 relay unit. If the feature is shared by all terminals, connect their A1 terminals; if, however, each terminal has its own feature, use an SAR-12/24 relay for each one and do not connect their A1 terminals.

This function is activated when button **AUX** of the terminal is pressed at any time (regardless of whether the terminal is in standby or function, call, communication or intercom mode).

The most common applications are activating the stairway lights and opening a second door.

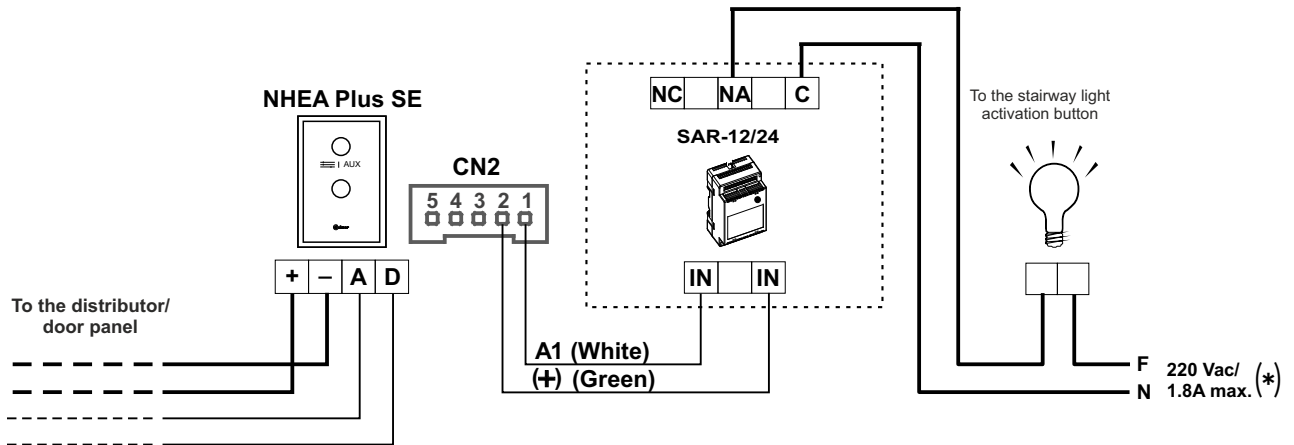

(*) The neutral of the lighting power supply is arranged serially through the contacts of the SAR-12/24 relay and the maximum consumption of the element to be connected does not exceed 1.8A.

To activate a second lock release, a TF-104 transformer is required.

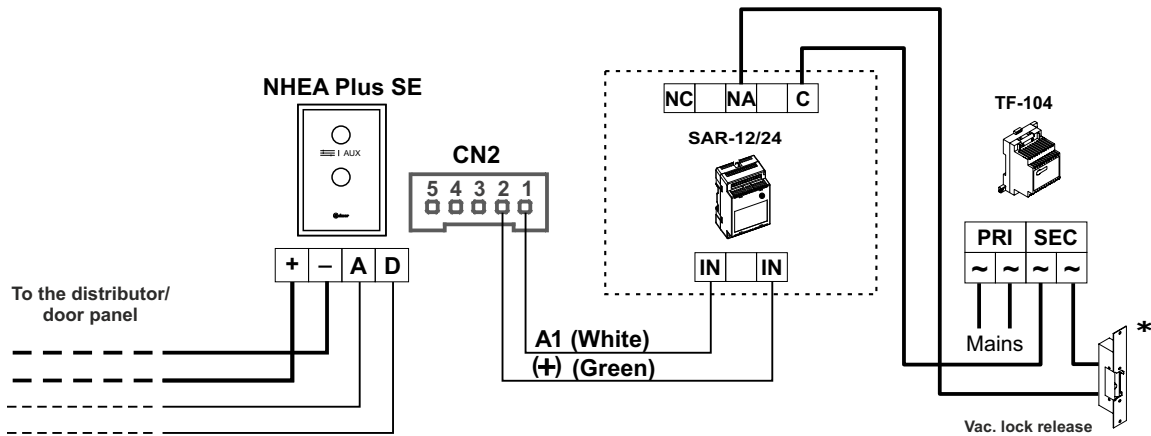

* **Important:** Place the varistor supplied with the sound module directly onto the terminals of the lock release.

Exterior button input for activating the door panel lock release:

This enables the door panel lock release to be activated during a call or communication with the door panel. With the terminal in standby, a panic call to the guard units configured to receive such calls is made.

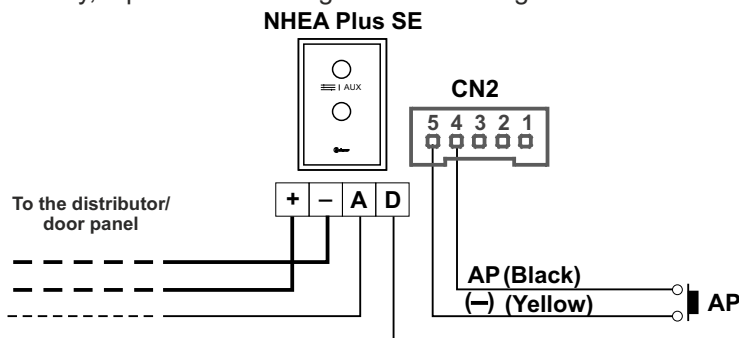



OPTIONAL CONNECTIONS

Continued from previous page.

Intercom between two points in the same apartment:

The NHEA Plus SE terminal features as standard an intercom function between two points in the same apartment. To enable this function, the following is necessary:

- One of the terminals needs to be configured as master and the other as slave with intercom, as described on p. 8. In the case of intercom between a monitor and a terminal, it is recommended to configure the monitor as the master.
- The INT terminal of the intercom devices needs to be connected (see diagram attached).
- Changing the function of button **AUX** by default with activation of aux devices 'A1' for 'intercom' (see p. 10).

To use the intercom function, enter function mode (press button  for 1 second), then press and hold button **AUX** until you hear a confirmation tone call all of the terminals in the apartment. To call individual devices, press the button once to call the 'master' terminal, twice to call 'slave 1', 3 times to call 'slave 2', 4 times to call 'slave 3' and 5 times to call 'slave 4'. This selective intercom call mode is only available with the Plus SE terminal, telephone and monitor. This only functions if no call or communication is in progress. A number of audible tones emitted by the terminal will confirm that the call is being made or that the unit being called is in communication with the door panel. To establish communication, press button  of the unit being called. If a call is received from the door panel during an intercom process, the terminal of the master unit will emit a number of audible tones. To establish communication with the door panel, press button  on the unit configured as master or press the door release button to simply open the door.

The ringtones vary depending on where the call is being made from, enabling the user to identify its origin.

Note: If the apartment also has T-540 Plus telephones, the NHEA Plus SE terminals must be configured as 'Intercom with Plus telephones/monitors' (see p. 9). This configuration mode does not allow selective intercom calls to different terminals/telephones in the apartment; when the intercom button is pressed, all of the terminals/telephones in the apartment will receive the call.

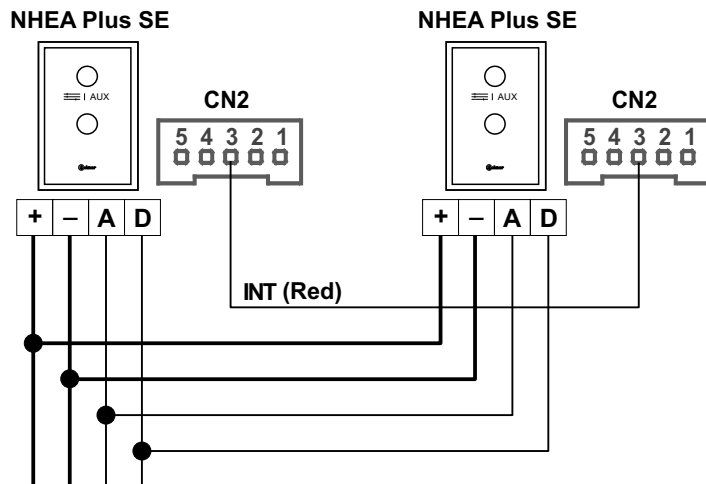

OPTIONAL CONNECTIONS

Continued from previous page.

Button for receiving calls from the apartment front door:

The NHEA Plus SE terminal features as standard the ability to receive calls from the apartment front door. This feature precludes the need to use the bell by positioning a switch between terminals 'HZ—' and '—' of the terminal.

The ringtones vary depending on where the call is being made from, enabling the user to identify its origin. If a call is made from the apartment front door during a conversation with the door panel or intercom, the terminal will emit a number of tones to indicate so.

Note: Regardless of the volume set for the terminal's ringtones (see p. 5) and the 'night mode' function, the 'apartment front door call' ringtone will always sound at maximum volume.

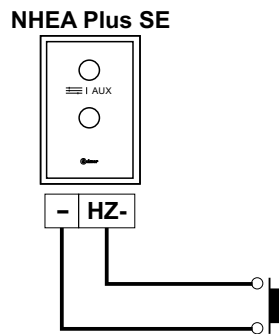

CLEANING THE TERMINAL

- Do not use solvents, detergents or cleaning products that contain acids, vinegar or abrasive components.
- Use a soft dry lint-free cloth.
- Always wipe the terminal in the same direction, from top to bottom, and without applying pressure.

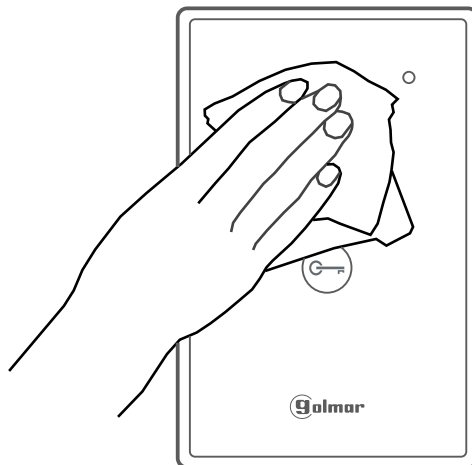

WIRING DIAGRAM

Audio door entry system:

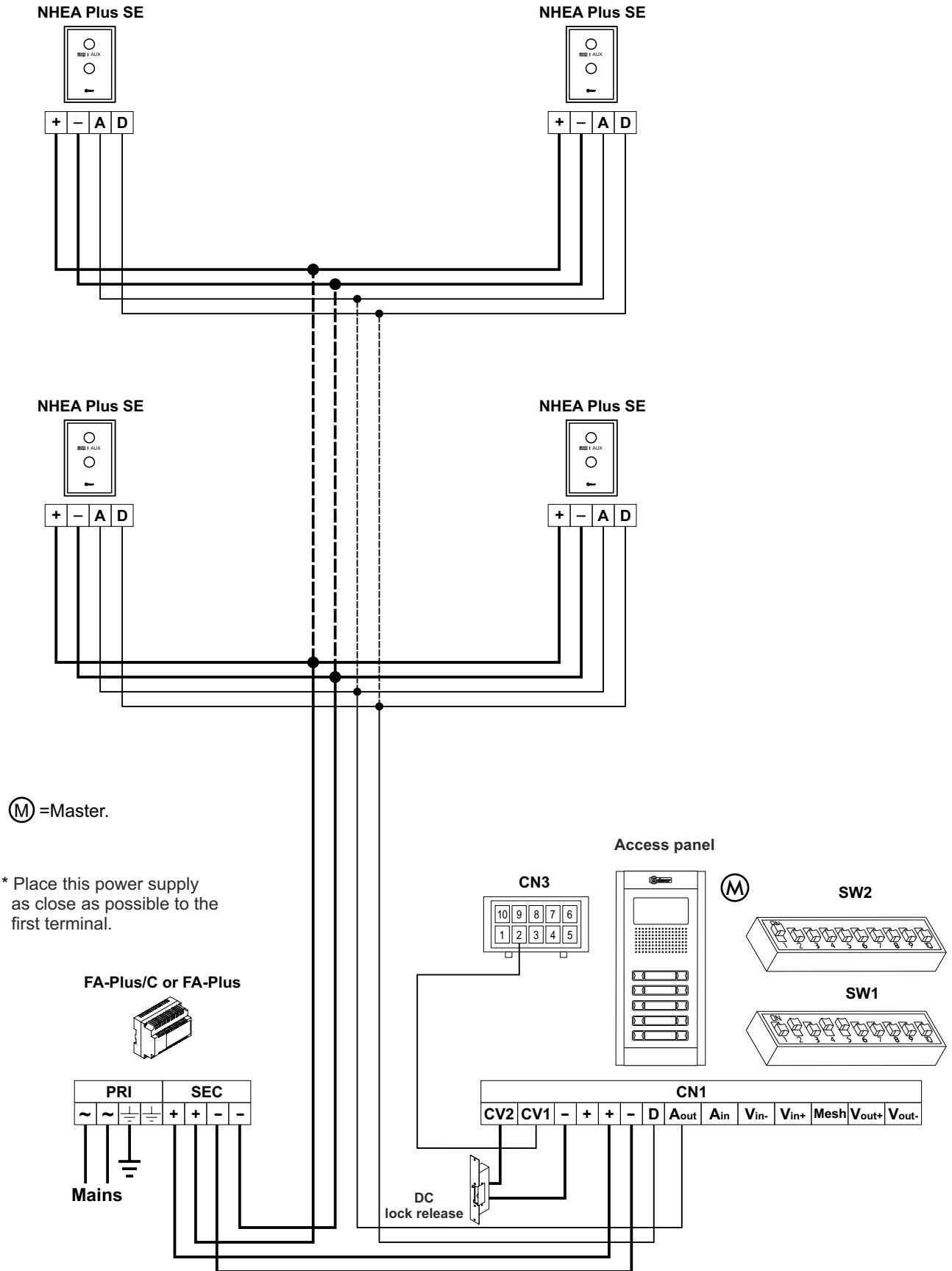

Important:

For further information about the door panel, sections, distances, other wiring diagrams, etc., see the T632 PLUS P/T ML Manual. <https://doc.golmar.es/search/manual/50122328>



golmar@golmar.es
www.golmar.es

GOLMAR S.A.
C/ Silici, 13
08940- Cornellá de Llobregat
SPAIN



Golmar se reserva el derecho a cualquier modificación sin previo aviso.
Golmar se réserve le droit de toute modification sans préavis.
Golmar reserves the right to make any modifications without prior notice.